

Lockout / Tagout

Hazardous Energy Control LOTO Devices

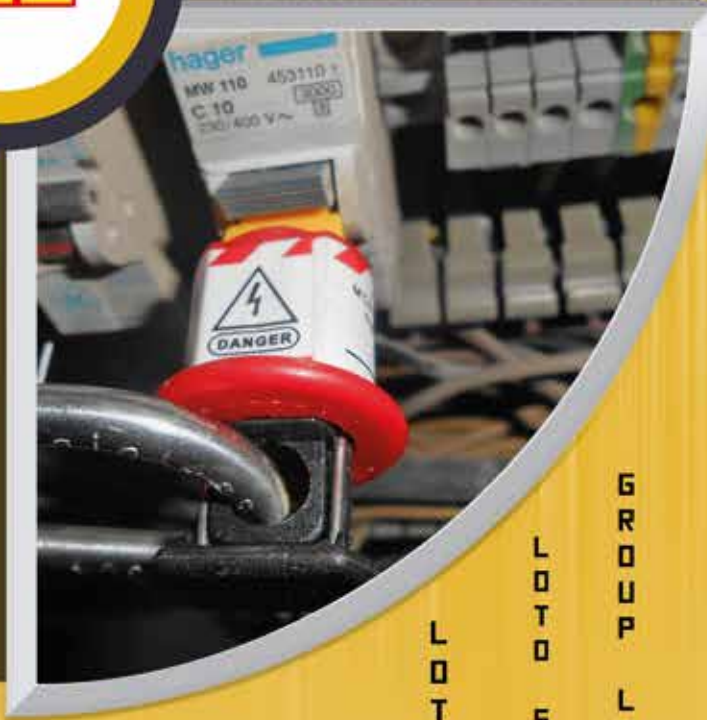

M E C H A N I C A L L O C K O U T S

V A L V E L O C K O U T S

C A B L E L O C K O U T S

K E Y C A B I N E T S

H A S P S

L O T O B A G S

L O T O S T A T I O N S

G R O U P L O C K O U T S

E L E C T R I C A L L O C K O U T S

HASPS

Model No.:	HSP-PMH-25R	
Description:	Hasp - Steel, PE Injection Molded	
	Handles, accommodates 6 Padlocks.	
	Size: Small, Color: Red.	
Size: 25 mm.	Dimensions:	
Brand: LOTO-LOK®	Origin: China	
Weight:	Packaging: 01 No.	



Model No.:	HSP-PMH-38R	
Description:	Hasp - Steel, PE Injection Molded	
	Handles, accommodates 6 Padlocks.	
	Size: Large, Color: Red.	
Size: 38 mm.	Dimensions:	
Brand: LOTO-LOK®	Origin: China	
Weight:	Packaging: 01 No.	



Model No.:	HSP-PMH-25B	
Description:	Hasp - Steel, PE Injection Molded	
	Handles, accommodates 6 Padlocks.	
	Size: Small, Color: Blue.	
Size: 25 mm.	Dimensions:	
Brand: LOTO-LOK®	Origin: China	
Weight:	Packaging: 01 No.	



Model No.:	HSP-PMH-38B	
Description:	Hasp - Steel, PE Injection Molded	
	Handles, accommodates 6 Padlocks.	
	Size: Large, Color: Blue.	
Size: 38 mm.	Dimensions:	
Brand: LOTO-LOK®	Origin: China	
Weight:	Packaging: 01 No.	



Model No.:	HSP-PMH-25Y	
Description:	Hasp - Steel, PE Injection Molded	
	Handles, accommodates 6 Padlocks.	
	Size: Small, Color: Yellow.	
Size: 25 mm.	Dimensions:	
Brand: LOTO-LOK®	Origin: China	
Weight:	Packaging: 01 No.	



Model No.:	HSP-PMH-38Y	
Description:	Hasp - Steel, PE Injection Molded	
	Handles, accommodates 6 Padlocks.	
	Size: Large, Color: Yellow.	
Size: 38 mm.	Dimensions:	
Brand: LOTO-LOK®	Origin: China	
Weight:	Packaging: 01 No.	



Model No.:	HSP-STL25-R	
Description:	Hasp - Steel, all metal construction for high temperature use. Accommodates 6 Padlocks. Color: Red.	
	Size: Small - 25mm	
	Dimensions:	
Brand: LOTO-LOK®	Origin: China	
Weight:	Packaging: 01 No.	



Model No.:	HSP-TAB-25	
Description:	Hasp - Steel, PE Injection Molded	
	Handles with Double Locking Tabs.	
	Size: Small, Color: Red.	
Size: 25 mm.	Dimensions:	
Brand: LOK-FORCE™	Origin: China	
Weight:	Packaging: 01 No.	



Model No.:	HSP-TAB-38	
Description:	Hasp - Steel, PE Injection Molded	
	Handles with Double Locking Tabs.	
	Size: Large, Color: Red.	
Size: 38 mm.	Dimensions:	
Brand: LOK-FORCE™	Origin: China	
Weight:	Packaging: 01 No.	



HASPS

Model No.:	HSP-AL-25	
Description:	Hasp - Aluminum Round Rod Scissor	
	Hasp, Nylon Injection Molded Handles. Size: Small. Color: Red.	
Size: 25 mm.	Dimensions:	
Brand: LOTO-LOK®	Origin: China	
Weight:	Packaging: 01 No.	



Model No.:	HSP-AL-38	
Description:	Hasp - Aluminum Round Rod Scissor	
	Hasp, Nylon Injection Molded Handles. Size: Large. Color: Red.	
Size: 38 mm.	Dimensions:	
Brand: LOTO-LOK®	Origin: China	
Weight:	Packaging: 01 No.	



Model No.:	HSP-SS316-25	
Description:	Hasp - Solid SS 316 Grade, Rust, Weather & Spark proof Hasp.	
	Accommodates 6 Padlocks.	
Size:	Dimensions:	
Brand: LOTO-LOK®	Origin: China	
Weight:	Packaging: 01 No.	



Model No.:	HSP-ALDS-2538	
Description:	Hasp - Aluminum, Dual jaw size	
	25/38 mm, Accommodates 8 Locks.	
Size: 25 x 38 mm.	Dimensions:	
Brand:	Origin: China	
Weight:	Packaging: 01 No.	



Model No.:	HSP-RNH-33	
Description:	Hasp - Nylon, Non-Conductive,	
	3.0mm Shackle diameter. Accommodates 3 Padlocks. Color: Red.	
Shackle dia: 3.0mm .		
Brand: LOTO-LOK®	Origin: China	
Weight:	Packaging: 01 No.	



Model No.:	HSP-RNH-36	
Description:	Hasp - Nylon, Non-Conductive,	
	6.0mm Shackle diameter. Accommodates 3 Padlocks. Color: Red.	
Shackle dia: 6.0 mm.		
Brand: LOTO-LOK®	Origin: China	
Weight:	Packaging: 01 No.	



Model No.:	HSP-RNH-65	
Description:	Hasp - Nylon, Non-Conductive,	
	5.0mm Shackle diameter. Accommodates 6 Padlocks. Color: Red.	
Shackle dia: 5.0 mm.		
Brand: LOTO-LOK®	Origin: China	
Weight:	Packaging: 01 No.	



Model No.:	HSP-RNH-66	
Description:	Hasp - Nylon, Non-Conductive,	
	6.0mm Shackle diameter. Accommodates 6 Padlocks. Color: Red.	
Shackle dia: 6.0 mm.		
Brand: LOTO-LOK®	Origin: China	
Weight:	Packaging: 01 No.	



Model No.:	HSP-DEY3	
Description:	Hasp - Nylon, Di-Electric	
	3.0mm Shackle diameter. Accommodates 4 Padlocks. Color: Yellow / Red.	
Shackle dia: 3.0 mm.		
Brand: LOTO-LOK®	Origin: China	
Weight:	Packaging: 01 No.	



HASPS

Model No.:	HSP-DEY6
Description:	Hasp – Nylon, Di-Electric
	6.0mm Shackle diameter. Accommodates 4 Padlocks. Color: Yellow / Red.
Shackle dia: 6.0 mm.	
Brand: LOTO-LOK®	Origin: China
Weight:	Packaging: 01 No.
	

Model No.:	HSP-SBS
Description:	Hasp – Steel, SHORT Shackle, Butterfly Type, Accommodates 4 Padlocks.
	4 Padlocks.
Dimensions: H82 x W60 x 10mm Dia.	
Brand:	Origin: China
Weight:	Packaging: 01 No.
	

Model No.:	HSP-SBL
Description:	Hasp – Steel, LONG Shackle, Butterfly Type, Accommodates 8 Padlocks.
	8 Padlocks.
Dimensions: H168 x W60 x 10mm Dia.	
Brand:	Origin: China
Weight:	Packaging: 01 No.
	

Model No.:	HSP-ALR-6
Description:	Hasp – Aluminum Alloy.
	Accommodates 6 Padlocks. Color: Red.
Dimensions: W77 x L190 mm.	
Brand:	Origin: China
Weight:	Packaging: 01 No.
	

Model No.:	HSP-ALH-25Y
Description:	Hasp – Aluminium with coated non-conductive shackle. 6 locks capacity. Color: Yellow / Black.
	6 locks capacity. Color: Yellow / Black.
Dimensions:	
Brand:	Origin: China
Weight:	Packaging: 01 No.
	

Model No.:	HSP-TS3-4L
Description:	Hasp – Nylon body with 3.5mm Steel shackle for small apertures. 4 Locks capacity. Color: Red.
	4 Locks capacity. Color: Red.
Shackle dia: 3.5mm Dia.	
Brand: LOTO-LOK®	Origin: China
Weight:	Packaging: 01 No.
	

Model No.:	HSP-SCORP
Description:	Hasp – Steel, Dual jaw size 25/38mm, Accommodates 6 Locks. Color: Red.
	Color: Red.
Dimensions: Standard	
Brand:	Origin: China
Weight:	Packaging: 01 No.
	

Model No.:	HSP-MST-724
Description:	Hasp – Aluminium with Snap-On Clip. Accommodates 5 padlocks. Available in 6 color labels Red, Yellow, Green, Blue, Orange & Black.
	Available in 6 color labels Red, Yellow, Green, Blue, Orange & Black.
Dimensions: 1-3/4in x 2-1/8in (44.5mm x 54mm)	
Jaw Clearance.	
Brand:	Origin: China
Weight:	Packaging: 01 No.
	

CABLE LOCKOUTS

Model No.:	CL-PM-2MB
Description:	Cable Lockout - Premier
	Multipurpose Lockout + Hasp function. Color: Red. Cable: Black.
Cable Size: Dia. 4.0mm x Length 1.80 Mtr.	
Brand: LOTO-LOK®	Origin: China
Weight:	Packaging: 01 No.
	

Model No.:	CL-SQCL-1.5MR
Description:	Cable Lockout - Economy Squeezer
	Multipurpose, Galv. steel cable PVC coated with brass end cap. Color: Red.
Cable Size: Dia. 3.8mm x Length 1.50 Mtr.	
Brand: LOTO-LOK®	Origin: China
Weight:	Packaging: 01 No.
<p>Metal cable with PVC coating - One type cable ONLY red color</p> 	

Model No.:	CL-SQALM-1.5MC
Description:	Cable Lockout - Aluminium body,
	SS 304 cable. Ideal for high heat and extreme temperatures. 8 padlock holes.
Color: Satin.	
Cable Size: Dia. 4.0mm x 1.5 mtrs length.	
Brand: LOTO-LOK®	Origin: China
Weight:	Packaging: 01 No.
	

Model No.:	CL-SQC-3225
Description:	Cable Lockout - Grip Type with NYLON
	cable for locking multiple isolators and panels. ABS & PC construction, accommodates 4 Padlocks. Cable Length: 2.5 Mtrs.
Cable Diameter: 3.2mm. Color: Red.	
Brand: LOQ-IT	Origin: China
Weight:	Packaging: 01 No.
	

Model No.:	CL-SQC-5025
Description:	Cable Lockout - Grip Type with STEEL
	PVC Coated Cable. ABS & PC construction accommodates 4 Padlocks. Color: Red.
Cable Length: 2.5 Mtrs. Cable Diameter: 5.0mm.	
Brand: LOQ-IT	Origin: China
Weight:	Packaging: 01 No.
	

Model No.:	CL-3F-4MC
Description:	Cable Lockout - Adjustable with
	Stainless Steel PVC coated cable with brass end cap. Color: Red.
Cable Size: Dia. 5/32" (4mm) x Length 0.9 Mtrs.	
Brand: LOQ-IT	Origin: China
Weight:	Packaging: 01 No.
	

Model No.:	CL-5F-4MC
Description:	Cable Lockout - Adjustable with
	Stainless Steel PVC coated cable with brass end cap. Color: Red.
Cable Size: Dia. 5/32" (4mm) x Length 1.5 Mtrs.	
Brand: LOQ-IT	Origin: China
Weight:	Packaging: 01 No.
	

Model No.:	CL-6F-4MC
Description:	Cable Lockout - Adjustable with
	Stainless Steel PVC coated cable with brass end cap. Color: Red.
Cable Size: Dia. 5/32" (4mm) x Length 1.8 Mtrs.	
Brand: LOQ-IT	Origin: China
Weight:	Packaging: 01 No.
	

Model No.:	CL-16F-4MC
Description:	Cable Lockout - Adjustable with
	Stainless Steel PVC coated cable with brass end cap. Color: Red.
Cable Size: Dia. 5/32" (4mm) x Length 5.0 Mtrs.	
Brand: LOQ-IT	Origin: China
Weight:	Packaging: 01 No.
	

CABLE LOCKOUTS

Model No.:	CL-6F-6MC
Description:	Cable Lockout - Adjustable with
	Stainless Steel PVC coated cable with brass end cap. Color: Red.
Cable Size: Dia. 1/4" (6mm) x Length 1.8 Mtrs.	
Brand: LOQ-IT	Origin: China
Weight:	Packaging: 01 No.
	

Model No.:	CL-FT-2MR
Description:	Cable Lockout - FISH type.
	PVC coated cable with brass end cap. Color: Red.
Cable Size: Dia. 5.0mm x Length 2.0 Mtrs.	
Brand:	Origin: China
Weight:	Packaging: 01 No.
	

Model No.:	CL-PSM-2MR
Description:	Cable Lockout - Premium Squeezer
	Multipurpose with Vinyl Coated Steel Cable. Color: Red.
Cable Size: Dia. 3.50mm x Length 2.0 Mtrs.	
Brand:	Origin: China
Weight:	Packaging: 01 No.
	

Model No.:	CL-UNI-3MC
Description:	Cable Lockout - GRIP-ON with
	spring cable locking mechanism. PVC coated with brass end cap.
Color: Red. Cable Size: Dia. 4.0mm x Length 1.6 Mtrs.	
Brand:	Origin: China
Weight:	Packaging: 01 No.
	

Model No.:	CL-FLX-6FB
Description:	Cable Lockout - HASP type
	Multipurpose applications. Black PVC coated cable with brass end cap.
Color: Red. Cable Size: Dia. 4.8mm x Length 1.8 Mtrs.	
Brand:	Origin: China
Weight:	Packaging: 01 No.
	

Model No.:	CL-UM-2MY
Description:	Cable Lockout - WHEEL type.
	PVC coated cable with brass end cap. Color: Yellow.
Cable Size: Dia. 4.0mm x Length 2.0 Mtrs.	
Brand:	Origin: China
Weight:	Packaging: 01 No.
	

KAB-O-LOK™ CABLE LOCKOUTS

Model No.:	CL-DEVR
Description:	Cable Lockout - Comprises Base +
	Tightening Wheel. Manufactured from heat resistant Nylon PA66 Color: Red.
Diameter 73mm x Height 37 mm.	
Brand: KAB-O-LOK™	Origin: China
Weight:	Packaging: 01 No.



Comprises Base & Tightening Wheel (Front Side)



Cable Management System (Back Side)

Model No.:	KABTOOL-R
Description:	KAB-TOOL Operating Tool for
	KAB-O-LOK™ Cable Lockout. Color: Red.
Diameter 76mm x Height 13 mm.	
Brand: KAB-O-LOK™	Origin: China
Weight:	Packaging: 01 No.



FRONT



BACK

Watch how KAB-O-LOK's superior features and function can save \$\$\$\$ on reducing downtime compared to similar cable lockouts.

https://www.youtube.com/watch?v=qHf1_b6FHfs

(3D Animation of KAB-O-LOK function and features)

https://www.youtube.com/watch?v=-a_9Qpy4NzI

(Live demonstration of locking valves with KAB-O-LOK cable lockout)

COMPONENTS

Comprises Base & Tightening Wheel with Steel Galvanized PVC Coated Cable



KAB-TOOL Operating Tool for KAB-O-LOK™ Cable



CABLE MANAGEMENT SYSTEM

KAB-O-LOK™ CABLE LOCKOUTS

Model No.:	CL-DEVY
Description:	Cable Lockout - Comprises Base +
	Tightening Wheel. Manufactured from heat resistant Nylon PA66 Color: Yellow.
Diameter 73mm x Height 37 mm.	
Brand: KAB-O-LOK™	Origin: China
Weight:	Packaging: 01 No.



Comprises Base & Tightening Wheel (Front Side)

Cable Management System (Back Side)

Model No.:	KABTOOL-Y
Description:	KAB-TOOL Operating Tool for
	KAB-O-LOK™ Cable Lockout. Color: Yellow.
Diameter 76mm x Height 13 mm.	
Brand: KAB-O-LOK™	Origin: China
Weight:	Packaging: 01 No.

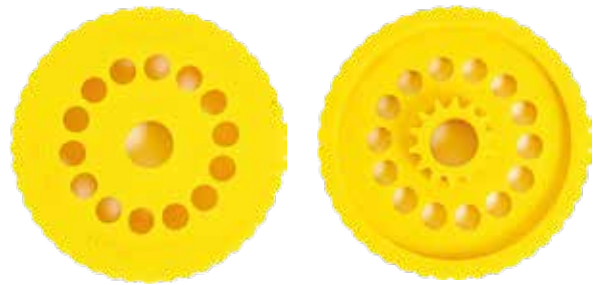

FRONT

BACK

Model No.:	CL-DEVG
Description:	Cable Lockout - Comprises Base +
	Tightening Wheel. Manufactured from heat resistant Nylon PA66 Color: Green.
Diameter 73mm x Height 37 mm.	
Brand: KAB-O-LOK™	Origin: China
Weight:	Packaging: 01 No.



Comprises Base & Tightening Wheel (Front Side)

Cable Management System (Back Side)

Model No.:	KABTOOL-G
Description:	KAB-TOOL Operating Tool for
	KAB-O-LOK™ Cable Lockout. Color: Green.
Diameter 76mm x Height 13 mm.	
Brand: KAB-O-LOK™	Origin: China
Weight:	Packaging: 01 No.



FRONT

BACK

PVC COATED CABLES FOR KAB-O-LOK™

Model No.:	CL-CAB2R
Description:	Cable - Steel Galvanised PVC coated with Aluminium eye at one end and crimped brass cap at other end. Color: Red.
Dimensions: I.D. 2.5mm x O.D. 3.8mm x L 2.0 Mtrs.	
Brand: KAB-O-LOK™	Origin: China
Weight:	Packaging: 01 No.
	

Model No.:	CL-CAB5R
Description:	Cable - Steel Galvanised PVC coated with Aluminium eye at one end and crimped brass cap at other end. Color: Red.
Dimensions: I.D. 2.5mm x O.D. 3.8mm x L 5.0 Mtrs.	
Brand: KAB-O-LOK™	Origin: China
Weight:	Packaging: 01 No.
	

Model No.:	CL-CAB10R
Description:	Cable - Steel Galvanised PVC coated with Aluminium eye at one end and crimped brass cap at other end. Color: Red.
Dimensions: I.D. 2.5mm x O.D. 3.8mm x L 10.0 Mtrs.	
Brand: KAB-O-LOK™	Origin: China
Weight:	Packaging: 01 No.
	

Model No.:	CL-CAB2Y
Description:	Cable - Steel Galvanised PVC coated with Aluminium eye at one end and crimped brass cap at other end. Color: Yellow.
Dimensions: I.D. 2.5mm x O.D. 3.8mm x L 2.0 Mtrs.	
Brand: KAB-O-LOK™	Origin: China
Weight:	Packaging: 01 No.
	

Model No.:	CL-CAB5Y
Description:	Cable - Steel Galvanised PVC coated with Aluminium eye at one end and crimped brass cap at other end. Color: Yellow.
Dimensions: I.D. 2.5mm x O.D. 3.8mm x L 5.0 Mtrs.	
Brand: KAB-O-LOK™	Origin: China
Weight:	Packaging: 01 No.
	

Model No.:	CL-CAB10Y
Description:	Cable - Steel Galvanised PVC coated with Aluminium eye at one end and crimped brass cap at other end. Color: Yellow.
Dimensions: I.D. 2.5mm x O.D. 3.8mm x L 10.0 Mtrs.	
Brand: KAB-O-LOK™	Origin: China
Weight:	Packaging: 01 No.
	

Model No.:	CL-CAB2G
Description:	Cable - Steel Galvanised PVC coated with Aluminium eye at one end and crimped brass cap at other end. Color: Green.
Dimensions: I.D. 2.5mm x O.D. 3.8mm x L 2.0 Mtrs.	
Brand: KAB-O-LOK™	Origin: China
Weight:	Packaging: 01 No.
	

Model No.:	CL-CAB5G
Description:	Cable - Steel Galvanised PVC coated with Aluminium eye at one end and crimped brass cap at other end. Color: Green.
Dimensions: I.D. 2.5mm x O.D. 3.8mm x L 5.0 Mtrs.	
Brand: KAB-O-LOK™	Origin: China
Weight:	Packaging: 01 No.
	

Model No.:	CL-CAB10G
Description:	Cable - Steel Galvanised PVC coated with Aluminium eye at one end and crimped brass cap at other end. Color: Green.
Dimensions: I.D. 2.5mm x O.D. 3.8mm x L 10.0 Mtrs.	
Brand: KAB-O-LOK™	Origin: China
Weight:	Packaging: 01 No.
	

KAB-O-LOK™ ACCESSORIES

Model No.:	CL-SPL-RD50M
Description:	CABLE SPOOL - Steel Galvanised
	PVC coated Cable. Color: Red.
	Cable Length: 50.0 Mtrs.
Size: (I.D. 2.5mm x O.D. 3.8mm)	
Brand: KAB-O-LOK™	Origin: China
Weight:	Packaging:

Spool of 50 Mtrs. Per Roll.



Model No.:	CL-SPL-GN50M
Description:	CABLE SPOOL - Steel Galvanised
	PVC coated Cable. Color: Green.
	Cable Length: 50.0 Mtrs.
Size: (I.D. 2.5mm x O.D. 3.8mm)	
Brand: KAB-O-LOK™	Origin: China
Weight:	Packaging:

Spool of 50 Mtrs. Per Roll.



Model No.:	CL-SPL-YL50M
Description:	CABLE SPOOL - Steel Galvanised
	PVC coated Cable. Color: Yellow.
	Cable Length: 50.0 Mtrs.
Size: (I.D. 2.5mm x O.D. 3.8mm)	
Brand: KAB-O-LOK™	Origin: China
Weight:	Packaging:

Spool of 50 Mtrs. Per Roll.



Model No.:	FRL-AL
Description:	Ferrule, Aluminium for crimping
	bare / coated cables up to 3.8mm dia.
Brand:	Origin: China
Weight:	Packaging:

Pack of 50 Pcs.



WHEEL VALVE LOCKOUTS

Model No.:	VL-PGT-2563
Description:	Valve Lockout - PREMIER.
	Locks Wheel Valves dia. between 25 - 63 mm. Color: Red.
Size: 25 - 63 mm.	
Brand: LOTO-LOK®	Origin: China
Weight:	Packaging:
	

Model No.:	VL-PGT-63125
Description:	Valve Lockout - PREMIER.
	Locks Wheel Valves dia. between 63 - 125 mm. Color: Red.
Size: 63 - 125 mm.	
Brand: LOTO-LOK®	Origin: China
Weight:	Packaging:
	

Model No.:	VL-PGT-125165
Description:	Valve Lockout - PREMIER.
	Locks Wheel Valves dia. between 125 - 165 mm. Color: Red.
Size: 125 - 165 mm.	
Brand: LOTO-LOK®	Origin: China
Weight:	Packaging:
	

Model No.:	VL-PGT-165250
Description:	Valve Lockout - PREMIER.
	Locks Wheel Valves dia. between 165 - 250 mm. Color: Red.
Size: 165 - 250 mm.	
Brand: LOTO-LOK®	Origin: China
Weight:	Packaging:
	

Model No.:	VL-PGT-250325
Description:	Valve Lockout - PREMIER.
	Locks Wheel Valves dia. between 250 - 325 mm. Color: Red.
Size: 250 - 325 mm.	
Brand: LOTO-LOK®	Origin: China
Weight:	Packaging:
	

Model No.:	VL-PGT-330450
Description:	Valve Lockout - PREMIER.
	Locks Wheel Valves dia. between 330 - 450 mm. Color: Red.
Size: 330 - 450 mm.	
Brand: LOTO-LOK®	Origin: China
Weight:	Packaging:
	

Model No.:	VL-PGT-25325
Description:	Valve Lockout - PREMIER.
	Locks Wheel Valves dia. between 25 - 325 mm. Color: Red.
(Set of 5 Pcs. Consisting of 25mm to 325mm)	
Size: 25 - 325 mm.	
Brand: LOTO-LOK®	Origin: China
Weight:	Packaging:
	

Model No.:	VL-PGT-25450
Description:	Valve Lockout - PREMIER.
	Locks Wheel Valves dia. between 25 - 450 mm. Color: Red.
(Set of 6 Pcs. Consisting of 25mm to 450mm)	
Size: 25 - 450 mm.	
Brand: LOTO-LOK®	Origin: China
Weight:	Packaging:
	

Model No.:	VL-GVLA-25125
Description:	Adjustable Gate Valve Lockout.
	Locks Valve Wheel Diameters between 25 - 125 mm.
Size: 25 - 125 mm.	
Brand: LOTO-LOK®	Origin: China
Weight:	Packaging:
	

WHEEL VALVE LOCKOUTS

Model No.:	VL-MST-F480
Description:	Valve Lockout - ROTATING.
	Locks Valve Wheel Dia. between 25 - 76 mm.
Size: 25 - 76 mm.	
Brand:	Origin: China
Weight:	Packaging:
	

Model No.:	VL-MST-F481
Description:	Valve Lockout - ROTATING.
	Locks Valve Wheel Dia. between 50 - 127 mm.
Size: 50 - 127 mm.	
Brand:	Origin: China
Weight:	Packaging:
	

Model No.:	VL-MST-F482
Description:	Valve Lockout - ROTATING.
	Locks Valve Wheel Dia. between 101 - 165 mm.
Size: 101 - 165 mm.	
Brand:	Origin: China
Weight:	Packaging:
	

Model No.:	VL-MST-F483
Description:	Valve Lockout - ROTATING.
	Locks Valve Wheel Dia. between 152 - 254 mm.
Size: 152 - 254 mm.	
Brand:	Origin: China
Weight:	Packaging:
	

Model No.:	VL-MST-F484
Description:	Valve Lockout - ROTATING.
	Locks Valve Wheel Dia. between 203 - 330 mm.
Size: 203 - 330 mm.	
Brand:	Origin: China
Weight:	Packaging:
	

Model No.:	VL-MST-F485
Description:	Valve Lockout - ROTATING.
	Locks Valve Wheel Dia. between 25 - 330 mm.
Size: 25 - 330 mm.	
Brand:	Origin: China
Weight:	Packaging:
<p>(Set of 5 Pcs. Consisting of F480 to F484)</p> 	

BALL VALVE LOCKOUTS

Model No.:	VL-BV-1032TL
Description:	Valve Lockout - BALL (Lever type).
	Locks Valve Sizes: 10 - 32 mm.
	Polypropylene construction. Color: Red.
Size: 10 - 32 mm.	
Brand:	Origin: China
Weight:	Packaging:



Model No.:	VL-BV-1364TL
Description:	Valve Lockout - BALL (Lever type).
	Locks Valve Sizes: 13 - 64 mm.
	Polypropylene construction. Color: Red.
Size: 13 - 64 mm.	
Brand:	Origin: China
Weight:	Packaging:



Model No.:	VL-BV-50200TL
Description:	Valve Lockout - BALL (Lever type).
	Locks Valve Sizes: 50 - 200 mm.
	Polypropylene construction. Color: Red.
Size: 50 - 200 mm.	
Brand:	Origin: China
Weight:	Packaging:

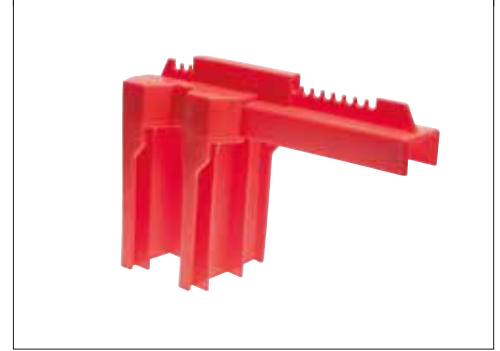

Model No.:	VL-BV-625STL
Description:	Valve Lockout - BALL
	(Steel Powder coated.) Color: Red.
	Locks Valve Sizes: 6 - 25 mm.
Size: 6 - 25 mm.	
Brand:	Origin: China
Weight:	Packaging:



Model No.:	VL-BV-3276STL
Description:	Valve Lockout - BALL
	(Steel Powder coated.) Color: Red.
	Locks Valve Sizes: 32 - 76 mm.
Size: 32 - 76 mm.	
Brand:	Origin: China
Weight:	Packaging:



Model No.:	VL-BV-625PVC
Description:	Valve Lockout - BALL
	(Steel Powder coated.) Color: Red.
	Two Piece PVC.
Size: 6 - 25 mm.	
Brand:	Origin: China
Weight:	Packaging:



Model No.:	VL-BV-HNDL
Description:	Valve Lockout - BALL Type, Seal Tight
	Handle-Off bag. Color: Red.
Bag Size: 324mm x 292 mm. Lock Diameter: 8mm	
Brand:	Origin: China
Weight:	Packaging: 01 No.

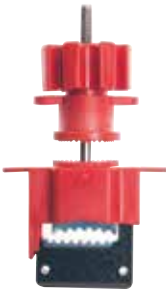

VALVE LOCKOUTS

Model No.:	VL-UNAC41-1
Description:	Valve Lockout - UNIVERSAL
	Base Only. Fits upto 40mm width, 19mm thk. handles.
Locks Lever size: Width 40mm x Thk. 19 mm.	
Brand: LOQ-IT	Origin: China
Weight:	Packaging:
	

Model No.:	VL-UNAC41-2
Description:	Valve Lockout - UNIVERSAL
	Base + 2.0 mtrs. cable. Fits upto 40mm width, 19mm thk. handles.
Locks Lever size: Width 40mm x Thk. 19 mm.	
Brand: LOQ-IT	Origin: China
Weight:	Packaging:
	

Model No.:	VL-UNAC41-3
Description:	Valve Lockout - UNIVERSAL
	Base + 1 Arm. Fits upto 40mm width, 19mm thk. handles.
Locks Lever size: Width 40mm x Thk. 19 mm.	
Brand: LOQ-IT	Origin: China
Weight:	Packaging:
	

Model No.:	VL-UNAC41-4
Description:	Valve Lockout - UNIVERSAL
	Base + Cable + 1 Arm. Fits upto 40mm width, 19mm thk. handles
Locks Lever size: Width 40mm x Thk. 19 mm.	
Brand: LOQ-IT	Origin: China
Weight:	Packaging:
	

Model No.:	VL-UNAC41-5
Description:	Valve Lockout - UNIVERSAL
	Base + 2 Arms. Fits upto 40mm width, 19mm thk. handles.
Locks Lever size: Width 40mm x Thk. 19 mm.	
Brand: LOQ-IT	Origin: China
Weight:	Packaging:
	

Model No.:	VL-UNAC41-6
Description:	Valve Lockout - UNIVERSAL
	Base + Cable + 2 Arms. Fits upto 40mm width, 19mm thk. handles.
Locks Lever size: Width 40mm x Thk. 19 mm.	
Brand: LOQ-IT	Origin: China
Weight:	Packaging:
	

Model No.:	VL-41-ARM
Description:	Blocking Arm for Universal Valve Lockout.
	Polypropylene materials, Color: Red.
Size:	Dimensions:
Brand:	Origin: China
Weight:	Packaging:
	

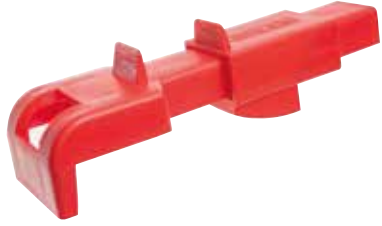
Model No.:	VL-BF-LEV
Description:	Valve Lockout - Butterfly
	construction, Locks Spring type Lever handle butterfly valves. Color: Red.
Size: Standard	Dimensions:
Brand: LOTO-LOK®	Origin: China
Weight:	Packaging:
	

Model No.:	VL-BF-SAN
Description:	Valve Lockout - Sanitary Butterfly
	Suitable for locking round handle sanitary valves. Locks 5mm - 25mm handle dia.
Size: 5 - 25 mm.	Dimensions:
Brand:	Origin: China
Weight:	Packaging:
	

BUTTERFLY & PLUG VALVE LOCKOUTS

Model No.:	VL-PVLO
Description:	Valve Lockout - Plug
	Locking range: 10~34mm rectangular valve stem; 15~50mm round valve stem.
Size:	
Brand:	Origin: China
Weight:	Packaging:
	

Model No.:	VL-BF-2P
Description:	Valve Lockout - Butterfly Valve
	Lockout Device + Cable Lockout.
	Suitable for locking out Spring type
Size:	Lever handle 0.8~4.5cm butterfly valves. Size: 0.8~4.5cm.
Brand:	Origin: China
Weight:	Packaging:
	

Model No.:	VL-BF-1P
Description:	Valve Lockout - Butterfly Valve
	Lockout Device Only (without Cable Lockout).
	Suitable for locking out Spring type
Size:	Lever handle 0.8~4.5cm butterfly valves. Size: 0.8~4.5cm.
Brand:	Origin: China
Weight:	Packaging:
	

FLANGE LOCKOUTS

Model No.:	FL-SM-1319
Description:	Flange Lockout - Aluminium alloy & hardened steel, suitable for blocking nuts on blind flanges, prevents unauthorized flange removal. Color: Red.
Size:	Locks nuts between 13 - 19mm
Brand: LOQ-IT	Origin: China
Weight:	Packaging: 01 No.
	

Model No.:	FL-MD-2332
Description:	Flange Lockout - Aluminium alloy & hardened steel, suitable for blocking nuts on blind flanges, prevents unauthorized flange removal. Color: Red.
Size:	Locks nuts between 23 - 32mm
Brand: LOQ-IT	Origin: China
Weight:	Packaging: 01 No.
	

Model No.:	FL-LG-3548
Description:	Flange Lockout - Aluminium alloy & hardened steel, suitable for blocking nuts on blind flanges, prevents unauthorized flange removal. Color: Red.
Size:	Locks nuts between 35 - 48mm
Brand: LOQ-IT	Origin: China
Weight:	Packaging: 01 No.
	

CIRCUIT BREAKER LOCKOUTS (MCB & MCCB)

Model No.:	CB-PI-CTBL
Description:	Circuit Breaker Locking Device
	PIN-IN for Single Pole MCB's.
	Color: Green.
Brand: LOTO-LOK®	Origin: China
Weight:	Packaging:



Model No.:	CB-PO-CTBL
Description:	Circuit Breaker Locking Device
	PIN-OUT for Single & Multipole MCB's.
	Color: Yellow.
Brand: LOTO-LOK®	Origin: China
Weight:	Packaging:



Model No.:	CB-POW-CTBL
Description:	Circuit Breaker Locking Device
	PIN-OUT- WIDE for Single & Multipole MCB's.
	Color: Blue
Brand: LOTO-LOK®	Origin: China
Weight:	Packaging:



Model No.:	CB-COMBO-CTBL
Description:	Circuit Breaker Locking Device - Pin Combo (SET OF 3) for Miniature Circuit Breaker. 1 off PIN - IN, 1 off PIN - OUT, & 1 off PIN - OUT - WIDE.
Brand: LOTO-LOK®	Origin: China
Weight:	Packaging:



Model No.:	CB-MG-CTBL
Description:	Circuit Breaker Locking Device - for Single & Multi Pole MCB's & MCCB's. Opened & closed with Screwdriver. Color: Yellow.
Brand: LOTO-LOK®	Origin: China
Weight:	Packaging:



Model No.:	CB-POL-Y
Description:	Circuit Breaker Locking Device
	PIN-OUT for Single & Multipole MCB's with LATCH. Color: Yellow
Brand: LOTO-LOK®	Origin: China
Weight:	Packaging:



Model No.:	CB-AB-CTBL
Description:	Circuit Breaker Locking Device - for Single & Multi Pole MCB's & MCCB's. Opened & closed with Screwdriver. Color: Blue.
Brand: LOTO-LOK®	Origin: China
Weight:	Packaging:



Model No.:	CB-FLRD
Description:	Circuit Breaker / Fuse lockout
	Screwdriver Required, Color: Red.
Brand:	Origin: China
Weight:	Packaging:



Model No.:	CB-UB-CTBL
Description:	Circuit Breaker Locking Device
	for Single Pole MCB's. Opened & closed with screwdriver. Color - Red.
Brand: LOTO-LOK®	Origin: China
Weight:	Packaging:



CIRCUIT BREAKER LOCKOUTS (MCB & MCCB)

Model No.:	CB-UNI-HT
Description:	Circuit Breaker Locking Device,
	Universal type for Single & Multipole MCB's & MCCB's upto 200A.
	Hand Tightening. NO-TOOL. Color: Red.
Brand: LOQ-IT	Origin: China
Weight:	Packaging:



Model No.:	CB-UNI-DTHT
Description:	Circuit Breaker Locking Device
	Universal type with Dove Tail for locking a wide range of MCCB's up to 200 Amps.
	Hand Tightening. NO-TOOL. Color: Red.
Brand: LOQ-IT	Origin: China
Weight:	Packaging:



Model No.:	CB-COV94
Description:	Circuit Breaker Locking Device - Universal
	type for Single & Multipole MCB's & MCCB's upto 200A with cover and 2 way padlocking slots. NO-TOOL. Color: Red.
Brand:	Origin: China
Weight:	Packaging:



Model No.:	CB-UNIHT-4ST
Description:	Circuit Breaker Locking Device
	Universal type for Multipole MCB & MCCB,
	Hand Tightening. NO-TOOL. Color: Red.
Brand: LOQ-IT	Origin: China
Weight:	Packaging:



Model No.:	CB-UNIDTHT-4ST
Description:	Circuit Breaker Locking Device
	Universal type for MCCB's. Hand Tightening. NO-TOOL. Color: Red.
Brand: LOQ-IT	Origin: China
Weight:	Packaging:



Model No.:	STL-CTBL
Description:	Circuit Breaker Locking Device -
	for Schneider MCCB's with multiple padlocking facility. Steel construction.
Brand:	Origin: China
Weight:	Packaging:



Model No.:	CB-TB
Description:	Circuit Breaker Locking Device -
	Tie Bar for Multi Pole MCB's.
	Color - Red.
Brand: LOTO-LOK®	Origin: China
Weight:	Packaging:



Model No.:	CB-UMPBL
Description:	Circuit Breaker Locking Device -
	Universal Multi Pole Circuit Breaker Lockout. Color: Red.
Brand: LOTO-LOK®	Origin: China
Weight:	Packaging:



Model No.:	CB-CLO
Description:	Circuit Breaker Locking Device
	Clamp on, Pin type for MCCB toggles with holes. Color: Red.
Brand: LOTO-LOK®	Origin: China
Weight:	Packaging:



CIRCUIT BREAKER LOCKOUTS (MCB & MCCB)

Model No.:	LSP - COMBO - 5SET
Description:	Circuit Breaker Locking Device
	Combo Circuit Breaker Lockout. Set of 5 Pcs.
Brand: LOTO-LOK®	Origin: China
Weight:	Packaging:



Model No.:	CB-BT-CTBL
Description:	Circuit Breaker Locking Device
	for MCCB's with Large Toggles upto 600 AMPS. Color: Red.
Brand: LOTO-LOK®	Origin: China
Weight:	Packaging:



Model No.:	CB-DUO-CTBL
Description:	Circuit Breaker Locking Device
	for MCB's & MCCB's. Accomodates different toggle sizes. Color: Red
Brand:	Origin: China
Weight:	Packaging:



Model No.:	CB-KT-S
Description:	Circuit Breaker Locking Device
	locks outs 277 Volts MCCB's with toggle widths 16mm x Thk. 11.5 mm.
Thumbwheel operation. Color: Red. Size: Small.	
Brand: LOQ-IT	Origin: China
Weight:	Packaging:



Model No.:	CB-KT-M
Description:	Circuit Breaker Locking Device
	locks outs 480/600Volts MCCB's with toggle widths 41mm x Thk. 13.5 mm.
Thumbwheel operation. Color: Red. Size: Medium.	
Brand: LOQ-IT	Origin: China
Weight:	Packaging:



Model No.:	CB-KT-L
Description:	Circuit Breaker Locking Device
	locks outs 480/600Volts MCCB's with Oversized toggle widths
	63mm x Thk. 22 mm. Thumbwheel operation. Color: Red. Size: Large.
Brand: LOQ-IT	Origin: China
Weight:	Packaging:



Model No.:	CB-LCB-RH
Description:	Circuit Breaker Locking Device -
	for MCCB with large toggles upto 600Amps. Round handle. NO-TOOL required. Accommodates multiple padlocks.
Brand:	Origin: China
Weight:	Packaging:



Model No.:	CB-LCB-HT
Description:	Circuit Breaker Locking Device - for MCCB
	with large toggles upto 600Amps. NO-TOOL required. Tightens by hand.
Brand:	Origin: China
Weight:	Packaging:





Model No.:	CB-MCB-S
Description:	Circuit Breaker Locking Device to lock
	MCB upto 49 mm body length. Nylon body with aluminium jaws.
Ideal for blocking MCB's. Color: Red	
Dimensions: Inner Lgth 49mm x Inner Width 30mm	
Brand: LOTO-LOK®	Origin: China
Weight:	Packaging: 01 No.

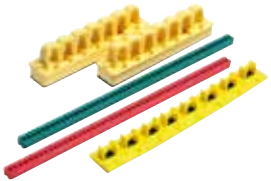

CIRCUIT BREAKER LOCKOUTS (MCB & MCCB)

Model No.:	CB-MCB
Description:	Circuit Breaker Locking Device to lock MCB upto 61 mm body length.
	Nylon body with aluminium jaws.
Ideal for blocking MCB's. Color: Red	
Dimensions: Inner Lgth 61mm x Inner Width 40mm	
Brand: LOTO-LOK®	Origin: China
Weight:	Packaging: 01 No.
	

Model No.:	CB-BBK-5
Description:	Circuit Breaker Locking Device locks out 600A MCCB's with Oversized toggles. (Break Blocker Components)
	480v~600v. Set consists of 2 self adhesive bases, 1 Red & 1 Green blocking bars and 1 self adhesive bar holder.
Brand:	Origin: China
Weight:	Packaging:
	

Model No.:	CB-MST-4093
Description:	Circuit Breaker Locking Device for MCCB's with small toggles.
	Color: Red. Size: Small.
Brand:	Origin: China
Weight:	Packaging:
	

Model No.:	CB-MST-4091
Description:	Circuit Breaker Locking Device for MCCB's with tall and wider Toggles.
	Color: Red. Size: Large.
Brand:	Origin: China
Weight:	Packaging:
	

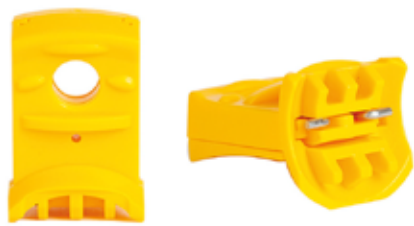
Model No.:	CB-SCNH-PO
Description:	Circuit Breaker Locking Device for PIN type single & multipole MCB's.
	Material: Nylon PA. Color: Yellow.
Brand:	Origin: China
Weight:	Packaging:
	

Model No.:	CB-DP-CTBL
Description:	Circuit Breaker Locking Device Locks 2 pole MCB's.
	Color: Red.
Brand:	Origin: China
Weight:	Packaging:
	

Model No.:	CB-SP-CTBL
Description:	Circuit Breaker Locking Device Locks Single Pole MCB's.
	Color: Red.
Brand:	Origin: China
Weight:	Packaging:
	

Model No.:	CB-MP-CTBL
Description:	Circuit Breaker Locking Device Locks Single Pole MCB's.
	Color: Red.
Brand:	Origin: China
Weight:	Packaging:
	

Model No.:	CB-TG-CTBL
Description:	Circuit Breaker Locking Device Locks 2 pole MCB's.
	Color: Red.
Brand:	Origin: China
Weight:	Packaging:
	

PANEL & PUSH BUTTON LOCKOUTS

Model No.:	PL-CIR-45
Description:	Panel Lockout - Push Button
	Polycarbonate material. Transparent.
	Circular Base 45mm Diameter.
Size: 45mm Dia.	Dimensions:
Brand: LOTO-LOK®	Origin: China
Weight:	Packaging:

Base permanently mounts on Panel with double sided tape.



Model No.:	PL-CIR-55
Description:	Panel Lockout - Push Button
	Polycarbonate material. Transparent.
	Circular Base 55mm Diameter.
Size: 55mm Dia.	Dimensions:
Brand: LOTO-LOK®	Origin: China
Weight:	Packaging:

Base permanently mounts on Panel with double sided tape.



Model No.:	PL-SQS-50
Description:	Panel Lockout - Push Button / Switch
	Polycarbonate material. Transparent.
	Inner Size: 58 x 58 mm.
Size: 58 x 58mm	Dimensions:
Brand: LOTO-LOK®	Origin: China
Weight:	Packaging:

Base permanently mounts on Panel with double sided tape.



Model No.:	PL-SQB-75
Description:	Panel Lockout - Push Button / Switch
	Polycarbonate material. Transparent.
	Inner Size: 58mm Height x 75mm Width.
Size: H 58 x W 75 mm.	Dimensions:
Brand: LOTO-LOK®	Origin: China
Weight:	Packaging:

Base permanently mounts on Panel with double sided tape.



Model No.:	PL-SQB-90
Description:	Panel Lockout - Push Button / Switch
	Acrylic material. Transparent.
Inner Size: 80mm Length x 80mm Width x 58mm Depth.	
Brand: LOTO-LOK®	Origin: India
Weight:	Packaging: 01 No.

Base permanently mounts on Panel with double sided tape.

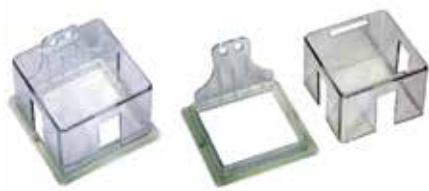

Model No.:	PL-EPB-90
Description:	Panel Lockout - Push Button Emergency
	Polycarbonate material. Transparent.
	30mm I.D. Base X 70mm Internal I.D.
Size: 30 x 70mm	Dimensions:
Brand: LOTO-LOK®	Origin: China
Weight:	Packaging:

Removable Device. Non-permanent.



Model No.:	PL-BT-22
Description:	Panel Lockout - Push Button
	Polycarbonate material. Transparent.
	Accommodates upto 22mm dia Base.
Size: 22mm I.D.	Dimensions:
Brand: LOTO-LOK®	Origin: China
Weight:	Packaging:

Device mounts permanently on Base of Push Button.



Model No.:	PL-BT-30
Description:	Panel Lockout - Push Button
	Polycarbonate material. Transparent.
	Accommodates upto 30mm dia Buttons.
Size: 30mm I.D.	Dimensions:
Brand: LOTO-LOK®	Origin: China
Weight:	Packaging:

Device mounts permanently on Base of Push Button.



Model No.:	PL-CB-22E53
Description:	Panel Lockout - Push Button
	Polycarbonate material. Transparent.
	Accommodates 22mm dia Buttons.
Size: 22 mm.	Dimensions:
Brand:	Origin: China
Weight:	Packaging:

Collar mounts permanently on Base of Push Button - Cover is removable.



PANEL & PUSH BUTTON LOCKOUTS

Model No.:	PL-CB-30E53	
Description:	Panel Lockout - Push Button	
	Polycarbonate material. Transparent.	
	Accommodates 30mm dia Buttons.	
Size: 30 mm.	Dimensions:	
Brand:	Origin: China	
Weight:	Packaging:	

Collar mounts permanently on Base of Push Button - Cover is removable.



Model No.:	PL-RC-22	
Description:	Panel Lockout - Push Button	
	Polycarbonate material. Clear/Red.	
	Accommodates 22mm dia Buttons.	
Size: 22 mm.	Dimensions:	
Brand:	Origin: China	
Weight:	Packaging:	

Device mounts permanently on Base of Push Button.



Model No.:	PL-RC-30	
Description:	Panel Lockout - Push Button	
	Polycarbonate material. Clear/Red.	
	Accommodates 30mm dia Buttons.	
Size: 30 mm.	Dimensions:	
Brand:	Origin: China	
Weight:	Packaging:	

Device mounts permanently on Base of Push Button.



Model No.:	PL-AD-2732	
Description:	Panel Lockout - Push Button Adjustable	
	Fits 27~32mm diameter push buttons and round switch knobs.	
	Dimensions:	
Size: 62 x 54mm Dia.	Dimensions:	
Brand:	Origin: China	
Weight:	Packaging:	

Removable Device. Non-permanent. Ideal for locking push buttons where the base cannot be removed.



FUSE LOCKOUTS

Model No.:	FL-BR-FW
Description:	Fuse Lockout - Four Way.
	Fits fuses 1/4", 9/32", 13/32" & 9/16" in size. Color: Red.
Size:	
Brand:	Origin: China
Weight:	Packaging:
	

Model No.:	FL-BR-TW
Description:	Fuse Lockout - Two Way
	Fits fuses 13/16", 11/16" & blade type fuses. Color: Red.
Size:	
Brand:	Origin: China
Weight:	Packaging:
	

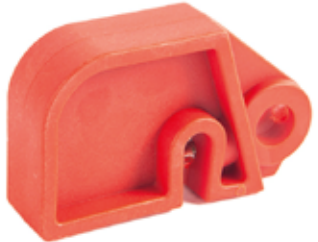
Model No.:	CB-FLRD
Description:	Circuit Breaker / Fuse lockout
	Screwdriver Required, Color: Red.
Size:	
Brand:	Origin: China
Weight:	Packaging:
	

WALL SWITCH LOCKOUTS

Model No.:	WSL-RD-MST
Description:	Wall Switch Lockout
	Color: Red.
Dimensions:	
Brand:	Origin: China
Weight:	Packaging:
	

Model No.:	WSL-443
Description:	Wall Switch Lockout
	Polycarbonate Lockable Single Switch Electrical Socket Covers.
Dimensions: 99.92 mm x 99.52 mm x 64.72 mm.	
Brand: LOTO-LOK®	Origin: China
Weight:	Packaging:
	

Model No.:	WSL-643
Description:	Wall Switch Lockout
	Polycarbonate Lockable Dual Switch Electrical Socket Covers.
Dimensions: 158.32 mm x 98.04 mm x 64.71 mm.	
Brand: LOTO-LOK®	Origin: China
Weight:	Packaging:
	

PNEUMATIC COUPLER LOCKOUTS

Model No.:	PNL-SS-612
Description:	Pneumatic Lockout - Stainless Steel
	Locks Male Connector sizes: 1/4", 3/8" & 1/2".
Dimensions: 1/4", 3/8" & 1/2".	
Brand:	Origin: China
Weight:	Packaging:



Model No.:	PNL-PLRD-612
Description:	Pneumatic Lockout - Nylon 3 Way.
	Locks Male Connector sizes: 1/4", 3/8" & 1/2". Color : Red.
Dimensions: 1/4", 3/8" & 1/2".	
Brand:	Origin: China
Weight:	Packaging:



CYLINDER, PLUG & PENDANT LOCKOUTS

Model No.:	PLG-RPL-Y
Description:	Plug Lockout - Electrical.
	Round, Color: Yellow
	Size: W 126 x L 160 x Ø 103mm.
Dimensions: 126 x 160 x Ø 103mm.	
Brand:	Origin: China
Weight:	Packaging:
	

Model No.:	PLG-RPL-R
Description:	Plug Lockout - Electrical.
	Round, Color: Red.
	Size: W 126 x L 160 x Ø 103mm.
Dimensions: 126 x 160 x Ø 103mm.	
Brand:	Origin: China
Weight:	Packaging:
	

Model No.:	PLG-LRPM
Description:	Plug Lockout - Electrical.
	Locks small & medium sized electrical plugs. Color: Red.
Dimensions: 65 x 65 x 118mm.	
Brand:	Origin: China
Weight:	Packaging:
	

Model No.:	PLG-LRPL
Description:	Plug Lockout - Electrical.
	Locks Large size electrical plugs.
	Color: Red.
Dimensions: 83 x 83 x 178mm.	
Brand:	Origin: China
Weight:	Packaging:
	

Model No.:	PLG-EP4H
Description:	Plug Lockout - Electrical / Pneumatic.
	Locks electrical plugs & pneumatic fittings. Color: Red.
Dimensions: 97 x 95 x 170mm.	
Brand:	Origin: China
Weight:	Packaging:
	

Model No.:	PLG-RND-SM
Description:	Plug Lockout - Rotating housing. Ideal for locking small electrical 2 or 3 pin plugs. Color: Red.
Dimensions: W 58 x H 95mm.	
Brand: LOTO-LOK®	Origin: China.
Weight:	Packaging: 01 No.
	

Model No.:	PLG-RND-LG
Description:	Plug Lockout - Rotating housing. Ideal for locking medium sized electrical sized plugs. Color: Red.
Dimensions: W 78 x H 169mm.	
Brand: LOTO-LOK®	Origin: China.
Weight:	Packaging: 01 No.
	

Model No.:	PNDT-9X9
Description:	Pendant & Plug Lockout.
	Color: Red. Size: Small.
	Lockouts Large Plugs & Small Pendants.
Dimensions: W9" x H9"	
Brand: LOTO-LOK®	Origin: India
Weight:	Packaging:
	

Model No.:	PNDT-9X12
Description:	Pendant & Plug Lockout.
	Color: Red. Size: Medium. Lockouts Extra Large Plugs & Small Pendants.
Dimensions: W9" x H12"	
Brand: LOTO-LOK®	Origin: India
Weight:	Packaging:
	

CYLINDER, PLUG & PENDANT LOCKOUTS

Model No.:	PNDT-9X18
Description:	Pendant & Plug Lockout.
	Color: Red. Size: Large.
	Lockouts Medium Pendants.
Dimensions:	W9" x H18"
Brand: LOTO-LOK®	Origin: India
Weight:	Packaging:



Model No.:	PNDT-9X26
Description:	Pendant & Plug Lockout.
	Color: Red. Size: Extra Large.
	Lockouts Large Pendants.
Dimensions:	W9" x H26"
Brand: LOTO-LOK®	Origin: India
Weight:	Packaging:



SPECIAL APPLICATION LOCKOUTS

Model No.:	MPD-YBPL-26
Description:	Switch Lockout Device – Panel Lockout with Adhesive Base. Color: Yellow.
	Locks knob switch & change over switch.
Size:	
Brand:	Origin: China
Weight:	Packaging:
Adhesive Base	
	

Model No.:	MPD-YBPL-27
Description:	Switch Lockout Device – Panel Lockout with Adhesive Base. Color: Yellow.
	Locks Push buttons & Covers Key Holes.
Size:	
Brand:	Origin: China
Weight:	Packaging:
Adhesive Base	
	

Model No.:	MPD-YBPL-28
Description:	Switch Lockout Device – Panel Lockout with Adhesive Base. Color: Yellow.
	Immobilises cabinet doors & Covers Key Holes.
Size:	
Brand:	Origin: China
Weight:	Packaging:
Adhesive Base	
	

Model No.:	MPD-YBPL-29
Description:	Switch Lockout Device – Panel Lockout with Adhesive Base. Color: Yellow.
	Lock switch handles & change over switch.
Size:	
Brand:	Origin: China
Weight:	Packaging:
Adhesive Base	
	

Model No.:	MPD-YBPL-30
Description:	Switch Lockout Device – Panel Lockout with Adhesive Base. Color: Yellow.
	Lock knife switches & Isolator handles.
Size:	
Brand:	Origin: China
Weight:	Packaging:
Adhesive Base	
	

CAR SEALS, TAGS & DISCS

Model No.:	CS-RED-1M
Description:	Car Seals - Aluminium / Zinc Body, Galvanized
	wire cable 1 mtr. Long, Self-Locking with Unique Serial No. printed on each piece. Color: Red.
Size: 2.5mm wire dia x 1mtr Length	
Brand: LOTO-LOK®	Origin: China
Weight:	Packaging:
	

Model No.:	CS-GRN-1M
Description:	Car Seals - Aluminium / Zinc Body, Galvanized
	Aircraft wire cable 1 mtr. Long, Self-Locking with Unique Serial No. printed on each piece. Color: Green.
Size: 2.5mm wire dia x 1mtr Length	
Brand: LOTO-LOK®	Origin: China
Weight:	Packaging:
	

Model No.:	CS-GRY-1M
Description:	Car Seals - Aluminium / Zinc Body, Galvanized
	Aircraft wire cable 1 mtr. Long, Self-Locking with Unique Serial No. printed on each piece. Color: Grey.
Size: 2.5mm wire dia x 1mtr Length	
Brand: LOTO-LOK®	Origin: China
Weight:	Packaging:
	

Model No.:	CS-BLU-1M
Description:	Car Seals - Aluminium / Zinc Body, Galvanized
	Aircraft wire cable 1 mtr. Long, Self-Locking with Unique Serial No. printed on each piece. Color: Blue.
Size: 2.5mm wire dia x 1mtr Length	
Brand: LOTO-LOK®	Origin: China
Weight:	Packaging:
	

Model No.:	CS-BLK-1M
Description:	Car Seals - Aluminium / Zinc Body, Galvanized Aircraft
	wire cable 1 mtr. Long, Self-Locking with Unique Serial No. printed on each piece. Color: Black.
Size: 2.5mm wire dia x 1mtr Length	
Brand: LOTO-LOK®	Origin: China
Weight:	Packaging:
	

Model No.:	CST-VLVC-R
Description:	Disc - "VALVE LOCKED CLOSED".
	Material: Stainless Steel 316. With 190 mm. Long stainless-steel wire. Color: Red
Size: 40mm Dia.	Thickness: 1 mm.
Brand:	Origin: China
Weight:	Packaging:
	

Model No.:	CST-VLVO-G
Description:	Disc - "VALVE LOCKED OPEN".
	Material: Stainless Steel 316. With 190 mm. Long stainless-steel wire. Color: Green.
Size: 40mm Dia.	Thickness: 1 mm.
Brand:	Origin: China
Weight:	Packaging:
	

Model No.:	TAGD-CSR
Description:	Tag - "CAR SEAL CLOSED". Color: Red.
	PVC Sheet with one side printing with Metal OR Punched Eyelet.
Size: W80mm x L160mm x Thk.0.5mm	
Brand:	Origin: China
Weight:	Packaging:
	

Model No.:	TAGD-CSG
Description:	Tag - "CAR SEAL OPEN". Color: Green.
	PVC Sheet with one side printing with Metal OR Punched Eyelet.
Size: W80mm x L160mm x Thk.0.5mm	
Brand:	Origin: China
Weight:	Packaging:
	

PIN & SLEEVE LOCKOUTS

Model No.:	PSL-S40
Description:	Pin & Sleeve Industrial socket lockout
	diameter 40mm, suitable for locking Small size sockets.
Size: 40mm dia.	
Brand:	Origin: China
Weight:	Packaging:
	

Model No.:	PSL-M44
Description:	Pin & Sleeve Industrial socket lockout
	diameter 44mm, suitable for locking Medium size sockets.
Size: 44mm dia.	
Brand:	Origin: China
Weight:	Packaging:
	

Model No.:	PSL-L50
Description:	Pin & Sleeve Industrial socket lockout
	diameter 50mm, suitable for locking Large size sockets.
Size: 50mm dia.	
Brand:	Origin: China
Weight:	Packaging:
	

Model No.:	PSL-XL63
Description:	Pin & Sleeve Industrial socket lockout
	diameter 63mm, suitable for locking Extra Large size sockets.
Size: 63mm dia.	
Brand:	Origin: China
Weight:	Packaging:
	

Model No.:	PSL-XL73
Description:	Pin & Sleeve Industrial socket lockout
	diameter 73mm, suitable for locking Extra Large size sockets.
Size: 73mm dia.	
Brand:	Origin: China
Weight:	Packaging:
	

LOTO STATIONS

Model No.:	LS-7L2P-Y
Description:	Lockout Station - Molded Plastic, durable & unbreakable. Configuration: 7 Hooks for Padlocks + 2 Tag Pockets (upto 10 Tags per pocket) + 2 Hooks (can store upto 2 Hasps per hook). Empty Station Only. Color: Yellow
Dimensions:	L300 x W400 mm.
Brand: LOTO-LOK®	Origin: China
Weight:	Packaging:



Model No.:	LS-7L2P-Y-CS
Description:	Lockout Station - Molded Plastic, durable & unbreakable. 7 Padlocks + 20 Tags + Cable Ties + Marker Pen + 2 Hasps. Complete Station with contents. Color: Yellow.
Dimensions:	L300 x W400 mm.
Brand: LOTO-LOK®	Origin: China
Weight:	Packaging:



Model No.:	LS-16L-1P-Y
Description:	Lockout Station - Molded Plastic, durable & unbreakable. Configuration: 16 Hooks for Padlocks + 1 Tag Pocket (upto 10 Tags) + 2 Hooks (can store upto 2 Hasps per hook). Empty Station Only. Color: Yellow.
Dimensions:	L350 x W360 mm.
Brand: LOTO-LOK®	Origin: China
Weight:	Packaging:



Model No.:	LS-16L-1P-Y-CS
Description:	Lockout Station - Molded Plastic, durable & unbreakable. 16 Padlocks + 10 Tags + Cable Ties + Marker Pen + 2 Hasps. Complete Station with contents. Color: Yellow.
Dimensions:	L350 x W360 mm.
Brand: LOTO-LOK®	Origin: China
Weight:	Packaging:



Model No.:	LS-ACST-24L2P-EB
Description:	Lockout Station - Heavy duty acrylic ideal for stocking Padlocks, Tags & Hasps. Configuration: 24 Hooks for Padlocks + 2 Tag Pockets (10 tags per pocket) + 2 Hooks (can store upto 2 Hasps per hook). Empty Station Only. Color: Yellow.
Dimensions:	L507 x W409 mm.
Brand: LOTO-LOK®	Origin: China
Weight:	Packaging:



Model No.:	LS-ACST-24L2P-CS
Description:	Lockout Station - Heavy duty acrylic construction, ideal for hanging Padlocks & Hasps. Clear pockets for Tags. 24 Padlocks + 20 Tags + Cable Ties + Marker Pen + 2 Hasps. Complete Station with contents. Color: Yellow.
Dimensions:	L507 x W409 mm.
Brand: LOTO-LOK®	Origin: China
Weight:	Packaging:

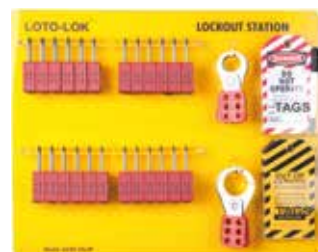

Model No.:	LS-ACST-48L4P-EB
Description:	Lockout Station - Heavy duty acrylic construction, ideal for stocking Padlocks, Tags & Hasps. Configuration: 48 Hooks for Padlocks + 4 Tag Pockets (10 Tags per pocket) + 2 Hooks (can store upto 2 Hasps per hook). Color: Yellow
Dimensions:	L685 x W604 mm.
Brand: LOTO-LOK®	Origin: China
Weight:	Packaging:





Model No.:	LS-ACST-48L4P-CS
Description:	Lockout Station - Heavy duty acrylic construction, ideal for hanging Padlocks & Hasps. Clear pockets for Tags. 48 Padlocks + 40 Tags + Cable Ties + Marker Pen + 4 Hasps. Complete Station with contents. Color: Yellow
Dimensions:	L685 x W604 mm.
Brand: LOTO-LOK®	Origin: China
Weight:	Packaging:



LOTO STATIONS

Model No.:	LS-MST04-EB
Description:	Lockout Station - Heavy duty molded plastic body with strong polycarbonate lockable cover.
	Ideal for stocking Padlocks, Hasps & Tags.
	Separate pocket stores Tags, Marker Pen & Cable Ties. Each hook can hang upto 2 Padlocks or Hasps. 5 Hooks + 1 Tag Pocket.
	Empty Station Only. Color: Yellow.
Dimensions: L320 x W420 x D70 mm.	
Brand:	Origin: China
Weight:	Packaging:
	

Model No.:	LS-MST04-CS
Description:	Lockout Station - Heavy duty molded plastic body with strong polycarbonate lockable cover.
	Ideal for stocking Padlocks & Hasps. Separate pocket stores Tags, Marker Pen & Cable Ties.
	Hooks are designed to hang 1 or 2 padlocks per hook. Can be customized to specific requirements.
	Complete Station with contents. Color: Yellow.
Dimensions: L320 x W420 x D70 mm.	
Brand:	Origin: China
Weight:	Packaging:
	

Model No.:	LS-MST10-EB
Description:	Lockout Station - Heavy duty molded plastic body with strong polycarbonate lockable cover.
	Ideal for stocking Padlocks, Hasps & Tags.
	Separate pocket stores Tags, Marker pen & Cable ties. Each hook can hang upto 2 Padlocks or Hasps. 15 Hooks + 2 Tag Pockets.
	Empty Station Only. Color: Yellow.
Dimensions: L400 x W560 x D70 mm.	
Brand:	Origin: China
Weight:	Packaging:
	

Model No.:	LS-MST10-CS
Description:	Lockout Station - Heavy duty molded plastic body with strong polycarbonate lockable cover.
	Ideal for stocking Padlocks & Hasps. Separate pocket stores Tags, Marker Pen & Cable Ties. Hooks are designed to hang 1 or 2 Padlocks per hook.
	Complete Station with contents.
	Color: Yellow.
Dimensions: L400 x W560 x D70 mm.	
Brand:	Origin: China
Weight:	Packaging:
	

Model No.:	LS-MST08P-EB	
Description:	Lockout Station - Polycarbonate w/cover. 8 Hooks to store Padlocks and Hasps (can store 2 padlocks / Hasps per hook) + bottom shelf to store Lockout / Tagout products.	
	Empty Station Only. Color: Yellow.	
	Dimensions: L574mm x W396mm x D108 mm.	
	Brand:	Origin: China
Weight:	Packaging:	
		

Model No.:	LS-SWC22H-4P
Description:	Lockout Station - Molded ABS + PC construction with locable door. Accommodate 20 Locks + 2 Hasps + 4 Tag Pockets.
	Color: Yellow. Station without contents.
Dimensions: L 625mm x W 590mm x D 97 mm.	
Brand: LOTO-LOK®	Origin: China.
Weight:	Packaging: 01 No.
	

Model No.:	LS-SWC22H-4P-CS
Description:	Lockout Station - Molded ABS + PC construction with locable door. 20 Padlocks, 2 Hasps, 40 Tags, Marker Pen & Cable Ties.
	Color: Yellow. Complete Station with contents.
Dimensions: L 625mm x W 590mm x D 97 mm.	
Brand: LOTO-LOK®	Origin: China.
Weight:	Packaging: 01 No.
	

Model No.:	LS-22H4PR
Description:	Lockout Station - Heavy duty Steel & powder coated construction with clear Acrylic Fascia. Accommodates 20 Locks + 2 Hasps + 4 Tag Pockets. Color: Red. Station without contents.
	Dimensions: 580mm x 430mm x 90mm.
Brand: LOTO-LOK®	Origin: China.
Weight:	Packaging: 01 No.
	

Model No.:	LS-22H4PR-CS
Description:	Lockout Station - Heavy duty Steel & powder coated construction with clear Acrylic Fascia. 20 Padlocks, 2 Hasps, 40 Tags, Marker Pen & Cable Ties. Color: Red. Complete Station with contents.
	Dimensions: 580mm x 430mm x 90mm.
Brand: LOTO-LOK®	Origin: China.
Weight:	Packaging: 01 No.
	

LOTO STATIONS

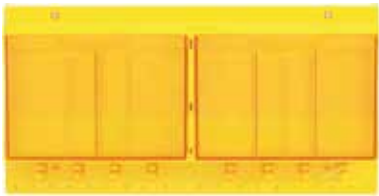
Model No.:	LS-MSTPT-EB
Description:	Lockout Station - Polycarbonate w/cover.
	8 Padlock Hooks and compartments to store Lockout / Tagout products.
	Color: Yellow. Empty Station Only.
Dimensions: L556mm x W280mm x D102 mm.	
Brand:	Origin: China
Weight:	Packaging:
	

Model No.:	LS-PRPPC-STN
Description:	Lockout Station - Polycarbonate construction w/cover.
	Portable + Wall hanging. Accomodate Padlocks + Tags or only Padlocks. Customizable.
	Color: Yellow. Station without contents.
Dimensions: L 408 mm x W 338 mm x D 98 mm	
Brand:	Origin: China.
Weight:	Packaging: 01 No.
	

Model No.:	LS-PRPPC-STN-CS
Description:	Lockout Station - Polycarbonate w/cover. Dual use & Adjustable, Portable + Wall hanging. Can be customized to accomodate padlocks + Tags or only Padlocks. Lockout / Tagout products.
	Color: Yellow. Station with contents.
	Dimensions: L 408 mm x W 338 mm x D 98 mm
Brand:	Origin: China
Weight:	Packaging:
	

Model No.:	LSM-6PD
Description:	Lockout Station - 6 Hooks for Padlocks / Hasps + 2 Tag Pockets and compartments to store LOTO products.
	Empty Station Only. Color: Yellow.
	Dimensions: L600 x W450 x D120 mm.
Brand: LOTO-LOK®	Origin: China
Weight:	Packaging:
	

Model No.:	LSM-10PD
Description:	Lockout Station - 10 Hooks for Padlocks / Hasps + 2 Tag Pockets and compartments to store LOTO products.
	Empty Station Only. Color: Yellow.
	Dimensions: L760 x W610 x D140 mm.
Brand: LOTO-LOK®	Origin: China
Weight:	Packaging:
	

Model No.:	LS-6CFY-EB
Description:	Lockout Station - Heavy duty steel construction, powder coated yellow, 2 adjustable shelves and door with clear acrylic fascia. Station is ideal for stocking a mix of Electrical & Mechanical LOTO Products. Empty Station Only. Color: Yellow.
	Dimensions: L360 x W450 x D155 mm.
	Brand: LOTO-LOK®
Weight:	Packaging:
	

Model No.:	LS-6STLY-EB
Description:	Lockout Station - Heavy duty steel construction, powder coated yellow, 2 adjustable shelves and Steel door. Station is ideal for stocking a mix of Electrical & Mechanical LOTO Products. Empty Station Only. Color: Yellow.
	Dimensions: L410 x W360 x D155 mm.
	Brand: LOTO-LOK®
Weight:	Packaging:
	

Model No.:	LS-10CFY
Description:	Lockout Station - Heavy duty steel construction, powder coated yellow, 2 adjustable shelves and door with clear acrylic fascia. Station is ideal for stocking a mix of Electrical & Mechanical LOTO Products. Empty Station Only. Color: Yellow.
	Dimensions: L600 x W550 x D250 mm.
	Brand: LOTO-LOK®
Weight:	Packaging:
	

Model No.:	LS-10STLY
Description:	Lockout Station - Heavy duty steel construction, powder coated yellow, 2 adjustable shelves and Steel door. Station is ideal for stocking a mix of Electrical & Mechanical LOTO Products. Empty Station Only. Color: Yellow.
	Dimensions: L600 x W550 x D250 mm.
	Brand: LOTO-LOK®
Weight:	Packaging:
	

LOTO STATIONS

Model No.:	LS-6CF-GLBY
Description:	Lockout Station - Clear Fascia with 2 adjustable shelves and Group Lock Box. Powder Coated Steel. Color: Yellow. Empty Box Only.
Dimensions: L 540 x W 360 x D 155 mm.	
Brand: LOTO-LOK®	Origin: China
Weight:	Packaging:
	

Model No.:	LS-STLY-9C-CF
Description:	Lockout Station - Heavy duty steel construction, powder coated yellow, 2 adjustable shelves, 5 Hooks for hanging Padlocks and door with clear acrylic fascia.
	Station is ideal for stocking a mix of Electrical & Mechanical LOTO Products.
	Empty Station Only. Color: Yellow.
Dimensions: L760 x W380 x D225 mm.	
Brand: LOTO-LOK®	Origin: India
Weight:	Packaging:
	

Model No.:	LS-STLR-9C-CF
Description:	Lockout Station - Heavy duty steel construction, powder coated red, 2 adjustable shelves, 5 Hooks for hanging Padlocks and door with clear acrylic fascia.
	Station is ideal for stocking a mix of Electrical & Mechanical LOTO Products.
	Empty Station Only. Color: Red.
Dimensions: L 765 x W 335 x D 235 mm.	
Brand: LOTO-LOK®	Origin: India
Weight:	Packaging:
	

Model No.:	LS-TRLY-MCY
Description:	Lockout Trolley - Portable, 2 wheels, 4 Compartments, for stocking various electrical & mechanical LOTO devices, Padlocks & Tags. Ideal & handy for shop floors
	where trolley can be wheeled on site. Reduces downtime.
Color: Yellow	
Dimensions: L 735 X W 490 X D 230 mm.	
Brand: LOTO-LOK®	Origin: China
Weight:	Packaging:
	

Model No.:	LTS-2S-PM-EB
Description:	Lockout Station - PP construction with handle. Portable + Wall mounting.
	Stores padlocks, devices & Tags.
Color: Yellow with lockable cover. Station without contents.	
Dimensions: L 430 x W 380 x H 150 mm.	
Brand:	Origin: China.
Weight:	Packaging: 01 No.
	

Model No.:	LS-8PTS
Description:	Tagout Station - 8 pockets. 8 clear acrylic pockets for accomodating tags upto 80mm width x 160mm length. Empty Station Only. Color: Yellow.
Dimensions: L 395 mm x W 445 mm.	
Brand: LOTO-LOK®	Origin: China
Weight:	Packaging:
	

LOTO STATIONS - SHADOW BOARDS

Model No.:	LS-SB6
Description:	Shadow Board - Aluminium frame.
	Cap: 6 Padlocks + 2 Hasps + 2 Tag Hooks. Empty Board Only.
Dimensions: L420 x W615 mm.	
Brand: LOTO-LOK®	Origin: China
Weight:	Packaging:



Model No.:	LS-SB6-CS
Description:	Shadow Board - Aluminium frame
	with 6 Padlocks + 2 Hasps + 20 Tags. Complete Station with contents.
Dimensions: L420 x W615 mm.	
Brand: LOTO-LOK®	Origin: China
Weight:	Packaging:



Model No.:	LS-SB12
Description:	Shadow Board - Aluminium frame.
	Cap: 12 Padlocks + 2 Hasps + 2 Tag Hooks. Empty Board Only.
Dimensions: L460 x W615 mm.	
Brand: LOTO-LOK®	Origin: China
Weight:	Packaging:



Model No.:	LS-SB12-CS
Description:	Shadow Board - Aluminium frame
	with 12 Padlocks + 2 Hasps + 20 Tags. Complete Station with contents.
Dimensions: L460 x W615 mm.	
Brand: LOTO-LOK®	Origin: China
Weight:	Packaging:



Model No.:	LS-SB24
Description:	Shadow Board - Aluminium frame.
	Cap: 24 Padlocks + 2 Hasps + 2 Tag Hooks. Empty Board Only.
Dimensions: L690 x W595 mm.	
Brand: LOTO-LOK®	Origin: China
Weight:	Packaging:



Model No.:	LS-SB24-CS
Description:	Shadow Board - Aluminium frame
	with 24 Padlocks + 2 Hasps + 20 Tags. Complete Station with contents.
Dimensions: L690 x W595 mm.	
Brand: LOTO-LOK®	Origin: China
Weight:	Packaging:



Model No.:	LS-SB36
Description:	Shadow Board - Aluminium frame.
	Cap: 36 Padlocks + 4 Hasps + 4 Tag Hooks. Empty Board Only.
Dimensions: L815 x W755 mm.	
Brand: LOTO-LOK®	Origin: China
Weight:	Packaging:



Model No.:	LS-SB36-CS
Description:	Shadow Board - Aluminium frame
	with 36 Padlocks + 4 Hasps + 40 Tags. Complete Station with contents.
Dimensions: L815 x W755 mm.	
Brand: LOTO-LOK®	Origin: China
Weight:	Packaging:





Model No.:	LS-SB50
Description:	Shadow Board - Aluminium frame.
	Cap: 50 Padlocks + 3 Hasps + 3 Tag Hooks. Empty Board Only.
Dimensions: L1000 x W735 mm.	
Brand: LOTO-LOK®	Origin: China
Weight:	Packaging:



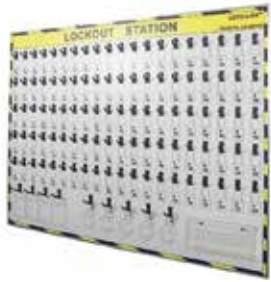

LOTO STATIONS - SHADOW BOARDS

Model No.:	LS-SB50-CS
Description:	Shadow Board - Aluminium frame
	with 50 Padlocks + 3 Hasps + 30 Tags. Complete Station with contents.
Dimensions: L1000 x W735 mm.	
Brand: LOTO-LOK®	Origin: China
Weight:	Packaging:
	

Model No.:	LS-SB100
Description:	Shadow Board - Aluminium frame.
	Cap: 100 Padlocks + 5 Hasps + 4 Tag
	Hooks. 1 Acrylic pocket for pens, clips & screwdrivers. Empty Board Only.
Dimensions: L1300 x W1005 mm.	
Brand: LOTO-LOK®	Origin: China
Weight:	Packaging:
	

Model No.:	LS-SB100-CS
Description:	Shadow Board - Aluminium frame with
	100 Padlocks + 5 Hasps + 40 Tags + Cable
	Ties + 1 Acrylic pocket for pens, clips & screwdrivers. Complete Station with contents.
Dimensions: L1300 x W1005 mm.	
Brand: LOTO-LOK®	Origin: China
Weight:	Packaging:
	

Model No.:	LS-SBEL
Description:	Shadow Board - Aluminium frame.
	Electrical Circuit Breaker Shadow Board.
	Cap: 4 Padlocks + 2 Hasps + 22 Circuit Breaker + 1 Tag Hook. Empty Board Only.
Dimensions: L450 x W600 mm.	
Brand: LOTO-LOK®	Origin: China
Weight:	Packaging:
	

Model No.:	LS-SBEL-CS
Description:	Shadow Board - Aluminium frame.
	Electrical Circuit Breaker Shadow Board
	with 4 Padlocks + 2 Hasps + 22 Circuit Breaker locking devices (various models) + 10 Tags. Complete Station with contents.
Dimensions: L450 x W600 mm.	
Brand: LOTO-LOK®	Origin: China
Weight:	Packaging:
	

Model No.:	LS-SBEM
Description:	Shadow Board - Electrical & Mechanical Shadow Board. Capacity: 8 Hooks for padlock + 10 Hooks for Hasp + 3 Hooks for Tag + 10 Hooks for Circuit Breaker Lockout + 3 Hooks for Cable Lockout + 5 Hooks for Gate Valve Lockout + 1 Acrylic Pocket. Empty Board Only.
Dimensions: L1220 x W840 mm.	
Brand: LOTO-LOK®	Origin: China
Weight:	Packaging:
	

Model No.:	LS-SBEM-CS
Description:	Shadow Board - Aluminium frame.
Electrical & Mechanical with 8 Padlocks + 10 Hasps + 30 Tags + 10 Circuit Breaker Lockout Devices + 3 Cable Lockouts + 5 Gate Valve Lockouts + 1 Acrylic Pocket (with cable ties, marker pen & screwdriver). Complete Station with content.	
Dimensions: L1220 x W840 mm.	
Brand: LOTO-LOK®	Origin: China
Weight:	Packaging:
	

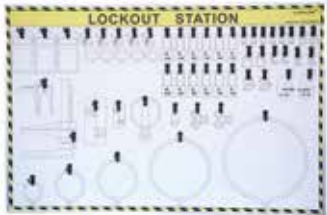
Model No.:	LS-SB-EMCM
Description:	Lockout Shadow Board Construction -
	PPC board with Aluminium alloy frame. Can be used for hanging a wide selection of Electrical & Mechanical Lockouts. Empty Station without contents.
Dimensions: H 800 mm x W 1220 mm.	
Brand: LOTO-LOK®	Origin: China
Weight:	Packaging:
	

Model No.:	LS-SB-EMCM-CS
Description:	Lockout Shadow Board Construction -
	PPC board with Aluminium alloy frame. Wide range of LOTO padlocks, Devices & Tags for Electrical & Mechanical Isolation. Complete Station with contents.
Dimensions: H 800 mm x W 1220 mm.	
Brand: LOTO-LOK®	Origin: China
Weight:	Packaging:
	

LOTO STATIONS - SHADOW BOARDS

Model No.:	LS-SB-EMGB
Description:	Lockout Shadow Board Construction – PPC board with Aluminium alloy frame. Accommodates a wide range of LOTO products for Electrical & Mechanical Isolation. Molded plastic Group Lock Box
Box 29 padlocks capacity can be installed. Inbuilt Acrylic Pocket. Station without contents.	
Dimensions: H 800 mm x W 1600 mm.	
Brand: LOTO-LOK®	Origin: China
Weight:	Packaging:

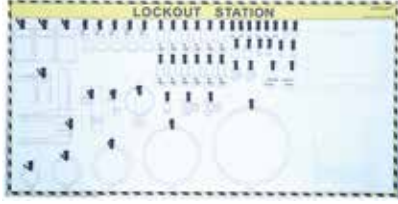

Model No.:	LS-SB-EMGB-CS
Description:	Lockout Shadow Board Construction – PPC board with Aluminium alloy frame. Wide range of LOTO products + Molded Group Lock Box 29 padlocks capacity & Acrylic Pocket for Electrical & Mechanical Isolation. Complete Station with contents.
Dimensions: H 800 mm x W 1600 mm.	
Brand: LOTO-LOK®	Origin: China
Weight:	Packaging:



Model No.:	LS-PTW-DH-CS
Description:	Lockout Shadow Board Construction – PPC board with Aluminium alloy frame, Upper part accommodates 3 yellow acrylic PTW / Document holders with group locking facility, acrylic pocket at bottom stores documents. Complete Station.
Dimensions: L 1200 x W 900 mm.	
Brand: LOTO-LOK®	Origin: India
Weight:	Packaging:



Model No.:	LS-SB-PHGLBY3
Description:	Shadow Board - Aluminium frame. Group Lockout. Capacity: 3 Permit Holder + 3 Group Lockout Box + 24 Padlock + 3 Tag Hooks. Empty Board Only.
Dimensions: L1220 x W1220 mm.	
Brand: LOTO-LOK®	Origin: India
Weight:	Packaging:

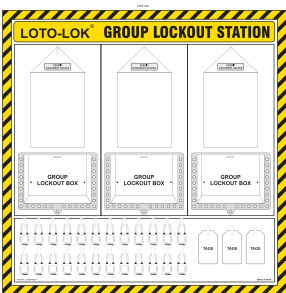

Model No.:	LS-SB-PHACP4
Description:	Shadow Board - Aluminium frame. Work Permit Station. Capacity: 4 Permit Document Holder + 4 Work Permit Holder Hooks. Empty Board Only.
Dimensions: L1200 x H900 mm.	
Brand: LOTO-LOK®	Origin: India
Weight:	Packaging:

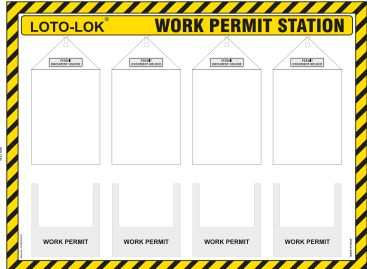

Model No.:	LS-SB-PHGLBR1
Description:	Shadow Board - Aluminium frame. Permit Control Board. Capacity: 1 Permit Document Holder Hook + 1 Group Lockout Box Holder. Empty Board Only.
Dimensions: L660 x W300 mm.	
Brand: LOTO-LOK®	Origin: India
Weight:	Packaging:

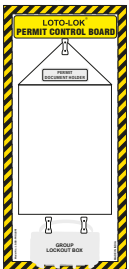

Model No.:	LS-SB-PHGLBY1
Description:	Shadow Board - Aluminium frame. Work Permit Station. Capacity: 1 Permit Document Holder Hook + 1 Group Lockout Box Holder. Empty Board Only.
Dimensions: L560 x W740 mm.	
Brand: LOTO-LOK®	Origin: India
Weight:	Packaging:

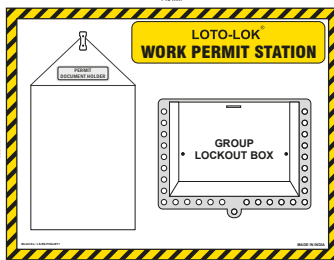

Model No.:	LS-SB-CLST4
Description:	Shadow Board - Aluminium frame. Cable Lockout Station Capacity: 4 Padlock + 2 Hasp + 1 Tag + 4 Cable Lockout Hooks. Empty Board Only.
Dimensions: L480 x W600 mm.	
Brand: LOTO-LOK®	Origin: India
Weight:	Packaging:

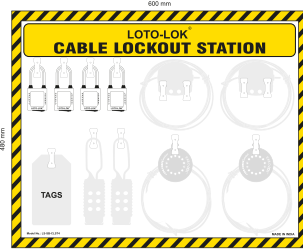

GROUP LOCKOUT STATIONS

Model No.:	GLB-SR13-TP
Description:	Group Lock Box - Steel, Powder coated RED color, accommodates 1 Primary & 12 secondary padlocks. Tag Pocket with
Chain holds 3 Tags for maintaining group locking details.	
Dimensions: L255 x W105 x H152mm.	
Brand: LOTO-LOK®	Origin: China
Weight:	Packaging:
	

Model No.:	GLB-SR13-NP
Description:	Group Lock Box - Steel, Powder coated RED color, accommodates 1 Primary & 12 secondary padlocks.
Dimensions: L255 x W105 x H152mm.	
Brand: LOTO-LOK®	Origin: China
Weight:	Packaging:
	

Model No.:	GLB-SR13B-NP
Description:	Group Lock Box - BIG (Portable), Red color powder coated, accommodates 1 Primary & 12 Secondary Padlocks.
Dimensions: 7.10" x 10" x 7.30"	
Brand: LOTO-LOK®	Origin: India
Weight:	Packaging: 01 No.
	

Model No.:	GLB-SY13-TP
Description:	Group Lock Box - Steel, Yellow color powder coated, accommodates 1 Primary & 12 Secondary Padlocks. Includes 3 Tags.
Dimensions: L 255 x W105 x H152mm.	
Brand: LOTO-LOK®	Origin: China
Weight:	Packaging:
	

Model No.:	GLB-SY13-NP
Description:	Group Lock Box - Steel, Yellow color powder coated, accommodates 1 Primary & 12 Secondary Padlocks. Includes 3 Tags.
Dimensions: L 255 x W105 x H152mm.	
Brand: LOTO-LOK®	Origin: China
Weight:	Packaging:
	

Model No.:	GLB-SRL7
Description:	Group Lock Box - Steel, Red color powder coated, accommodates 1 Primary & 6 Secondary Padlocks.
Dimensions: L110 x W100 x D185mm.	
Brand: LOTO-LOK®	Origin: China
Weight:	Packaging:
	

Model No.:	GLB-WMB-R5
Description:	Group Lock Box - Steel construction, Wall Mounted.Upper & lowers hangers accommodates upto 12 Padlocks. 5 molded hooks inside box can hang multiple keys. Station without contents. Color: Red.
Dimensions: 230mm x 150mm x 90mm.	
Brand: LOTO-LOK®	Origin: China.
Weight:	Packaging: 01 No.
	

Model No.:	GLB-WHMST-R
Description:	Group Lock Box - Steel Powder coated. 12 Built-in Keys Hanger. Accommodates 14 Padlocks outside. Color: Red.
Dimensions: L 163 x W 85 x D 260mm.	
Brand: LOTO-LOK®	Origin: China
Weight:	Packaging:
	

Model No.:	GLB-AL-83
Description:	Group Lock Box - Aluminium Const. with tough Polycarbonate sliding cover & PTW holder. Accommodates upto 83 Padlocks with 4 key Hooks. Color: Red.
Dimensions: L 680 x W 340 x D 35mm.	
Brand: LOTO-LOK®	Origin: China
Weight:	Packaging:
	

GROUP LOCKOUT STATIONS

Model No.:	GLB-PLX18
Description:	Group Lock Box - Acrylic construction Hinged door, 6 keys hangers. Accommodates 16 Padlocks. Color: Red.
Dimensions: L200 x W150 x D90mm.	
Brand:	Origin: China
Weight:	Packaging:
	

Model No.:	GLB-PLBRD-1
Description:	Group Lock Box - ABS & PC construction. Hinged door, 4 keys hangers. Accommodates 8 Padlocks. Color: Red.
Dimensions: L100 x W115 x D155mm.	
Brand:	Origin: China
Weight:	Packaging:
	

Model No.:	GLB-PLBRD-2
Description:	Group Lock Box - ABS & PC construction. Hinged door, 6 keys hangers with key drop facility. Portable. Color: Red.
Dimensions: L200 x W90 x D162mm.	
Brand:	Origin: China
Weight:	Packaging:
	

Model No.:	GLB-WM-7
Description:	Group Lock Box - Steel Powder coated. 7 Key Hooks. Accommodates 7 Padlocks. Portable & Wall Mounting. Color: Red.
Dimensions: L 208 x W 208 x D 155mm.	
Brand: LOTO-LOK®	Origin: India.
Weight:	Packaging:
	

Model No.:	GLB-WH-12
Description:	Group Lock Box - Steel Powder coated. 15 Key Hooks. Accommodates 12 Padlocks. Portable & Wall Mounting. Color: Red.
Dimensions: L238 x W432 x D60mm.	
Brand: LOTO-LOK®	Origin: India.
Weight:	Packaging:
	

Model No.:	GLB-GL-1-8K
Description:	Group Lock Box - Steel Powder coated. 10 Key Hooks. Accommodates 10 Padlocks. Portable & Wall Mounting. Color: Red.
Dimensions: L310 x W305 x D80mm.	
Brand:	Origin: India.
Weight:	Packaging:
	

Model No.:	GLB-GLK-2
Description:	Group Lock Box - Steel Powder coated. 10 Key Hooks. Accommodates 9 Padlocks Portable & Wall Mounting. Color: Red.
Dimensions: L 310 x W 305 x D 80mm.	
Brand: LOTO-LOK®	Origin: India.
Weight:	Packaging:
	

Model No.:	GLB-GLK-3
Description:	Group Lock Box - Steel Powder coated. 40 Key Hooks. Accommodates 9 Padlocks Portable & Wall Mounting. Color: Red.
Dimensions: L 476 x W 318 x D 80mm.	
Brand: LOTO-LOK®	Origin: India.
Weight:	Packaging:
	

Model No.:	GLB-AR3KH
Description:	Group Lock Box - Acrylic construction with hinged door & 3 key hooks. Accommodates 5 Padlocks. Color: Red.
Dimensions: L150 x W150 x D60mm.	
Brand:	Origin: China
Weight:	Packaging:
	

GROUP LOCKOUT STATIONS

Model No.:	GLB-AR8KH
Description:	Group Lock Box - Acrylic construction with hinged door & 8 key hooks.
	Accommodates 8-10 Padlocks. Color: Red.
Dimensions: L 300 x W 190 x D 67mm.	
Brand:	Origin: China
Weight:	Packaging:



Model No.:	GLB-AR15KH
Description:	Group Lock Box - Acrylic construction with hinged door & 15 key hooks.
	Accommodates 10-15 Padlocks. Color: Red.
Dimensions: L 400 x W 190 x D 60mm.	
Brand:	Origin: China
Weight:	Packaging:



Model No.:	GLB-MB-4
Description:	Group Lock Box - SS304 Mini Box with 4 padlocks capacity. One Internal shelf accommodates keys and small fuses. Color: Yellow.
	Dimensions: L 158 mm x W 158 mm x D 54 mm.
Brand: LOTO-LOK®	Origin: China.
Weight:	Packaging: 01 No.



Model No.:	GLB-WMY-29H
Description:	Group Lock Box - Sliding door with key drop facility. Accommodates 29 Padlocks & 16 key hooks each. Color: Yellow.
	Dimensions: L 330 x W 265 x D 85mm.
Brand:	Origin: India.
Weight:	Packaging:

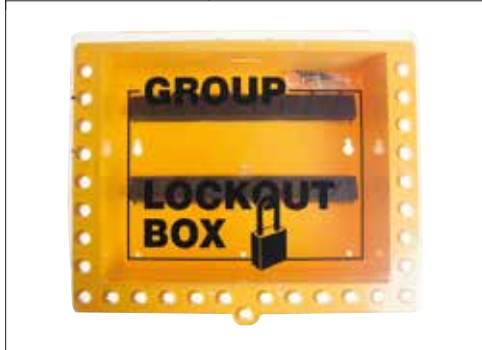

PADLOCK CABINETS

Model No.:	CABP-STLR-21-CF
Description:	Padlock Cabinet - 21 Locks Capacity.
	Durable Powder Coated Steel Cabinet with Clear Acrylic Fascia & 21 Hooks.
Dimensions: L450 x W375 x D100mm.	
Brand: LOTO-LOK®	Origin: India.
Weight:	Packaging:



Model No.:	CABP-STLR-28-CF
Description:	Padlock Cabinet - 28 Locks Capacity.
	Durable Powder Coated Steel Cabinet with Clear Acrylic Fascia & 28 Hooks.
Dimensions: L585 x W390 x D55mm.	
Brand: LOTO-LOK®	Origin: India.
Weight:	Packaging:



Model No.:	CABP-STLR-50-CF
Description:	Padlock Cabinet - 50 Locks Capacity.
	Durable Powder Coated Steel Cabinet with Clear Acrylic Fascia & 50 Hooks.
Dimensions: L 715 X W 505 X D 55 mm.	
Brand: LOTO-LOK®	Origin: India.
Weight:	Packaging:



Model No.:	CABP-STLR-60-CF
Description:	Padlock Cabinet - 60 Locks Capacity.
	Durable Powder Coated Steel Cabinet with Clear Acrylic Fascia & 60 Hooks.
Dimensions: L 860 X W 505 X D 55 mm.	
Brand: LOTO-LOK®	Origin: India.
Weight:	Packaging:



Model No.:	CABP-STLR-112
Description:	Padlock Cabinet - 112 Locks Capacity.
	Durable Powder Coated Cabinet with 112 Hooks & Steel door.
Dimensions: L584 x W393 x D139mm.	
Brand: LOTO-LOK®	Origin: India.
Weight:	Packaging:



Model No.:	CABP-STLR-220
Description:	Padlock Cabinet - 220 Locks Capacity.
	Durable Powder Coated Cabinet with 220 Hooks & Steel door.
Dimensions: L584 x W800 x D139mm.	
Brand: LOTO-LOK®	Origin: India.
Weight:	Packaging:



WALL MOUNTED PADLOCK STATIONS

Model No.:	PS-HANG6
Description:	Padlock Station - Wall mounted. 6 Locks Capacity. Color: Red
Dimensions: H 40 x W 140 x H 80mm.	
Brand: LOTO-LOK®	Origin: China
Weight:	Packaging:



Model No.:	PS-HANG12
Description:	Padlock Station - Wall mounted. 12 Locks Capacity. Color: Red
Dimensions: H 85 x W 27 x D 45mm.	
Brand: LOTO-LOK®	Origin: China
Weight:	Packaging:



Model No.:	PS-HANG18
Description:	Padlock Station - Wall mounted. 18 Locks Capacity. Color: Red
Dimensions: H 80 x W 400 x D 40mm.	
Brand: LOTO-LOK®	Origin: China
Weight:	Packaging:



Model No.:	PS-HANG24
Description:	Padlock Station - Wall mounted. 24 Locks Capacity. Color: Red
Dimensions: H 85 x W 530 x D 45mm.	
Brand: LOTO-LOK®	Origin: China
Weight:	Packaging:



KEY SAFE BOXES

Model No.:	KSB-3L
Description:	KEY SAFE BOX - 3 LOCK SYSTEM.
	1 Control Lock (KA) + 2 Secondary Locks (KD) with 2 internal shelves.
	1.2mm Steel Fabrication. Color: Grey.
Dimensions: H230 x W150 x D120mm.	
Brand: LOTO-LOK®	Origin: China
Weight:	Packaging:
	

Model No.:	KSB-5L
Description:	KEY SAFE BOX - 5 LOCK SYSTEM.
	1 Control Lock (KA) + 4 Secondary Locks (KD) with 2 internal shelves.
	1.2mm Steel Fabrication. Color: Grey.
Dimensions: H230 x W150 x D120mm.	
Brand: LOTO-LOK®	Origin: China
Weight:	Packaging:
	

Model No.:	KSB-7L
Description:	KEY SAFE BOX - 7 LOCK SYSTEM.
	1 Control Lock (KA) + 6 Secondary Locks (KD) with 2 internal shelves.
	1.2mm Steel Fabrication. Color: Grey.
Dimensions: H230 x W150 x D120mm.	
Brand: LOTO-LOK®	Origin: China
Weight:	Packaging:
	

Model No.:	KSB-5L300
Description:	KEY SAFE BOX - 5 LOCK SYSTEM.
	1 Control Lock (KA) + 4 Secondary Locks (KD) with 2 internal shelves.
	1.2mm Steel Fabrication. Color: Grey.
Dimensions: H305 x W305 x D104mm.	
Brand: LOTO-LOK®	Origin: China
Weight:	Packaging:
	

Model No.:	KSB-8L300
Description:	KEY SAFE BOX - 8 LOCK SYSTEM.
	1 Control Lock (KA) + 7 Secondary Locks (KD) with 2 internal shelves.
	1.2mm Steel Fabrication. Color: Grey.
Dimensions: H305 x W305 x D104mm.	
Brand: LOTO-LOK®	Origin: China
Weight:	Packaging:
	

Model No.:	KSB-5L300-H-STL
Description:	KEY SAFE BOX - 5 LOCK SYSTEM.
	1 Control Lock (KA) + 4 Secondary Locks (KD) with 28 Hooks for hanging keys. 1.2mm Mild Steel Fabrication. Color: Grey
Dimensions: H 305 x W 305 x D 104mm.	
Brand: LOTO-LOK®	Origin: China.
Weight:	Packaging: 01 No.
	

Model No.:	KSB-8L300-H-STL
Description:	KEY SAFE BOX - 8 LOCK SYSTEM.
	1 Control Lock (KA) + 4 Secondary Locks (KD) with 28 Hooks for hanging keys. 1.2mm Mild Steel Fabrication. Color: Grey
Dimensions: H 305 x W 305 x D 104mm.	
Brand: LOTO-LOK®	Origin: China.
Weight:	Packaging: 01 No.
	

Model No.:	KSB-5L300-H-SS
Description:	KEY SAFE BOX - 5 LOCK SYSTEM.
	1 Control Lock (KA) + 4 Secondary Locks (KD) with 28 Hooks for hanging keys. 1.2mm Stainless Steel 304 Fabrication. Color: Grey
Dimensions: H 305 x W 305 x D 104mm.	
Brand: LOTO-LOK®	Origin: China.
Weight:	Packaging: 01 No.
	

Model No.:	KSB-8L300-H-SS
Description:	KEY SAFE BOX - 8 LOCK SYSTEM.
	1 Control Lock (KA) + 4 Secondary Locks (KD) with 28 Hooks for hanging keys. 1.2mm Stainless Steel 304 Fabrication. Color: Grey
Dimensions: H 305 x W 305 x D 104mm.	
Brand: LOTO-LOK®	Origin: China.
Weight:	Packaging: 01 No.
	

LOK-FORCE™ KEY CABINETS

Model No.:	KC-LFLD-50
Description:	Key Cabinet - Rolled steel construction, Fixed hooks, 2 keys per lock, Plastic Key Tags & Wall mounting hardware included.
Dimensions:	240 x 300 x 75mm
Brand: LOK-FORCE™	Origin: China
Weight:	Packaging:



Model No.:	KC-LFHD-50
Description:	Key Cabinet - Rolled steel construction, Adjustable numbered hooks, 2 keys per lock, Plastic key Tags & Wall Mounting hardware included. Color: Grey.
Dimensions:	550 x 380 x 80mm
Brand: LOK-FORCE™	Origin: China
Weight:	Packaging:



Model No.:	KC-LFHD-100
Description:	Key Cabinet - Rolled steel construction, Adjustable numbered hooks, 2 keys per lock, Plastic key Tags & Wall Mounting hardware included. Color: Grey.
Dimensions:	550 x 380 x 80mm
Brand: LOK-FORCE™	Origin: China
Weight:	Packaging:



Model No.:	KC-LFHD-150
Description:	Key Cabinet - Rolled steel construction, Adjustable numbered hooks, 2 keys per lock, Plastic key Tags & Wall Mounting hardware included. Color: Grey.
Dimensions:	380 x 550 x 140mm
Brand: LOK-FORCE™	Origin: China
Weight:	Packaging:



Model No.:	KC-LFHD-200
Description:	Key Cabinet - Rolled steel construction, Adjustable numbered hooks, 2 keys per lock, Plastic key Tags & Wall Mounting hardware included. Color: Grey.
Dimensions:	380 x 550 x 140mm
Brand: LOK-FORCE™	Origin: China
Weight:	Packaging:



Model No.:	KC-LFHD-300
Description:	Key Cabinet - Rolled steel construction, Adjustable numbered hooks, 2 keys per lock, Plastic key Tags & Wall Mounting hardware included. Color: Grey.
Dimensions:	550 x 380 x 205mm
Brand: LOK-FORCE™	Origin: China
Weight:	Packaging:



Model No.:	KC-LFHD-400
Description:	Key Cabinet - Rolled steel construction, Adjustable numbered hooks, 2 keys per lock, Plastic key Tags & Wall Mounting hardware included. Color: Grey.
Dimensions:	730 x 550 x 140mm
Brand: LOK-FORCE™	Origin: China
Weight:	Packaging:



Model No.:	KC-LFHD-600
Description:	Key Cabinet - Rolled steel construction, Adjustable numbered hooks, 2 keys per lock, Plastic key Tags & Wall Mounting hardware included. Color: Grey.
Dimensions:	730 x 550 x 205mm
Brand: LOK-FORCE™	Origin: China
Weight:	Packaging:



Model No.:	KC-LFHD-1170
Description:	Key Cabinet - Rolled steel construction, Adjustable numbered hooks, 2 keys per lock, Plastic key Tags & Wall Mounting hardware included. Color: Grey.
Dimensions:	1300 x 730 x 250mm
Brand: LOK-FORCE™	Origin: China
Weight:	Packaging:



LOK-FORCE™ KEY CABINETS

Model No.:	KC-LFDKC-40
Description:	Key Cabinet Digital - Battery operated, Rolled steel construction, Fixed hooks with numbered key tags, 2 keys per lock, Plastic Key Tags & Wall mounting hardware included.
Dimensions:	270 x 308 x 65mm
Brand: LOK-FORCE™	Origin: China
Weight:	Packaging:



Model No.:	KC-LFDKC-60
Description:	Key Cabinet Digital - Battery operated, Rolled steel construction, Fixed hooks with numbered key tags, 2 keys per lock, Plastic Key Tags & Wall mounting hardware included.
Dimensions:	432 x 330 x 65mm
Brand: LOK-FORCE™	Origin: China
Weight:	Packaging:



Model No.:	KC-LFDKC-120
Description:	Key Cabinet Digital - Battery operated, Rolled steel construction, Fixed hooks with numbered key tags, 2 keys per lock, Plastic Key Tags & Wall mounting hardware included.
Dimensions:	375 x 432 x 65mm
Brand: LOK-FORCE™	Origin: China
Weight:	Packaging:



Model No.:	KC-LFEKC-3
Description:	Key Cabinet Emergency - Rolled steel construction, 3 fixed key hooks & hammer, 2 keys per lock, Plastic Key Tags & Wall mounting hardware included.
Dimensions:	120 x 150 x 80mm
Brand: LOK-FORCE™	Origin: China
Weight:	Packaging:

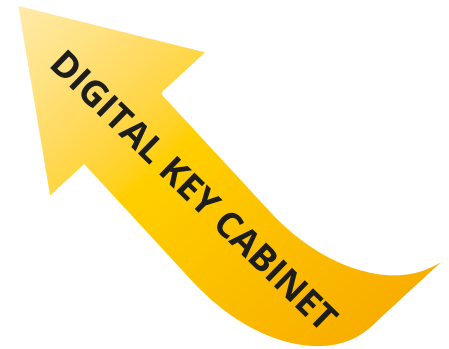

Model No.:	CAB-SB
Description:	Suggestion Box with external pocket for holding forms, Rolled steel construction, 2 keys per lock, Wall mounting hardware included.
Dimensions:	215 x 185 x 150mm
Brand: LOK-FORCE™	Origin: China
Weight:	Packaging:

Model No.:	KT-50
Description:	Plastic Key Tags - Normal. Assorted colors: Red, Yellow, Green, Blue, White & Black.
Dimensions:	
Brand: LOK-FORCE™	Origin: China
Weight:	Packaging:



Model No.:	KT-63
Description:	Plastic Key Tags - Heavy Duty Assorted colors: Red, Yellow, Green, Blue, White, Orange & Purple.
Dimensions:	
Brand: LOK-FORCE™	Origin: China
Weight:	Packaging:



Model No.:	KT-52
Description:	Plastic Key Tag - White slotted.
Dimensions:	
Brand: LOK-FORCE™	Origin: China
Weight:	Packaging:



KEY CABINETS

Model No.:	KCG10K
Description:	Key Cabinet - 10 Key Capacity, with plastic key tags and indexing card.
	Color: Grey.
Dimensions: W220 x D45 x H110mm.	
Brand: HELIX	Origin: China
Weight:	Packaging:
Till Stocks Last	
	

Model No.:	KCG20K
Description:	Key Cabinet - 20 Key Capacity, with plastic key tags and indexing card.
	Color: Grey.
Dimensions: W220 x D45 x H110mm.	
Brand: HELIX	Origin: China
Weight:	Packaging:
Till Stocks Last	
	

Model No.:	KCG30K
Description:	Key Cabinet - 30 Key Capacity, with plastic key tags and indexing card.
	Color: Grey.
Dimensions: W190 x D45 x H150mm.	
Brand: HELIX	Origin: China
Weight:	Packaging:
Till Stocks Last	
	

Model No.:	KCG80K
Description:	Key Cabinet - 80 Key Capacity, with plastic key tags and indexing card.
	Color: Grey.
Dimensions: W 275 x D 70 x H 275mm.	
Brand: HELIX	Origin: China
Weight:	Packaging:
Till Stocks Last	
	

Model No.:	KCG100K
Description:	Key Cabinet - 100 Key Capacity, with plastic key tags and indexing card.
	Color: Grey.
Dimensions: W 310 x D 70 x H 400mm.	
Brand: HELIX	Origin: China
Weight:	Packaging:
Till Stocks Last	
	

Model No.:	KC-30-CF
Description:	Key Cabinet - Manufactured by Metal Sheet with locking locking arrangement, 30 Keys Capacity with Clear Fascia.
Dimensions: L 360 x W 258 x D 55 mm.	
Brand: LOTO-LOK®	Origin: China.
Weight:	Packaging:
	

Model No.:	KC-60-CF
Description:	Key Cabinet - Manufactured by Metal Sheet with locking locking arrangement, 60 Keys Capacity with Clear Fascia.
Dimensions: L 460 x W 390 x D 55mm.	
Brand: LOTO-LOK®	Origin: China.
Weight:	Packaging:
	

Model No.:	KC-100-CF
Description:	Key Cabinet - Manufactured by Metal Sheet with locking locking arrangement, 100 Keys Capacity with Clear Fascia.
Dimensions: H 590 x W 520 x D 60 mm.	
Brand: LOTO-LOK®	Origin: China.
Weight:	Packaging:
	

Model No.:	KC-CF-320
Description:	Key Cabinet - 320 Keys capacity Durable Powder Coated Steel Cabinet with Clear Acrylic Fascia. Color: Yellow.
Dimensions: L 790 x W 460 x D 105mm.	
Brand: LOTO-LOK®	Origin: India
Weight:	Packaging:
	

LOTO POUCHES & BAGS

Model No.:	BG-RD21BP
Description:	LOTO BAG - Belt Pouch
	1680D Polyester heavy duty construction. 2 Pockets, Color: Red.
Dimensions:	20.5 x 10 x 14cms.
Brand: LOK-FORCE™	Origin: China
Weight:	Packaging:
	

Model No.:	BG-YW36MN
Description:	LOTO BAG - Mini Tote
	1680D Polyester heavy duty construction. Color: Yellow.
Dimensions:	36 x 13 x 15cms.
Brand: LOK-FORCE™	Origin: China
Weight:	Packaging:
	

Model No.:	BG-YR45SB
Description:	LOTO BAG - Shoulder
	1680D Polyester heavy duty construction. Multi pockets for organising different LOTO products & small tools. Color: Yellow/Red.
Dimensions:	45 x 22 x 32cms.
Brand: LOK-FORCE™	Origin: China
Weight:	Packaging:
	

Model No.:	BG-RD61WP
Description:	LOTO BAG - Waist Pouch - Heavy Duty,
	Extremely durable, Red color, 3 Pocket Waist Pouch manufactured from 1680D Grade Polyester. Color: Red
Dimensions:	61 x 16. x 17cms.
Brand: LOK-FORCE™	Origin: China
Weight:	Packaging:
	

Model No.:	BG-YR32SM
Description:	LOTO BAG - Hand Carry Bag - Small
	Heavy Duty Red color bag, Material 1680D Polyester. Color: Yellow / Red.
Dimensions:	31.5 x 23 x 27cms.
Brand: LOK-FORCE™	Origin: China
Weight:	Packaging:
	

Model No.:	BG-YR39MD
Description:	LOTO BAG - Hand Carry Bag - Medium
	Heavy Duty Red color bag, Material 1680D Polyester. Color: Yellow / Red.
Dimensions:	39 x 26 x 28cms.
Brand: LOK-FORCE™	Origin: China
Weight:	Packaging:
	

Model No.:	BG-YR47LG
Description:	LOTO BAG - Trolley Bag - Large
	Heavy duty construction w / Trolley Wheels. Material 1680D Polyester. Color: Yellow / Red.
Dimensions:	45 x 27 x 30cms.
Brand: LOK-FORCE™	Origin: China
Weight:	Packaging:
	

Model No.:	BG-RD62EG
Description:	Electrical Gear Bag - Duffle Tote
	Color: Red. With Silk Screen printed "ELECTRICAL GEAR" on front side of bag.
Dimensions:	62 x 32 x 37cms.
Brand: LOK-FORCE™	Origin: China
Weight:	Packaging:
	

**POUCHES & BAGS CAN BE
 CUSTOMIZED WITH COMPANY
 NAMES / LOGOS BASED ON
 MINIMUM QUANTITIES.**

E-MAIL: INFO@LOTOSAFETYPRODUCTS.COM

LOCKOUT / TAGOUT COMPLIANCE CENTRES

Model No.:	LSP-01
Description:	SDS STATION - Safety Data Sheets
	includes PVC coated wire rack on panel + one binder to store up to 300 data sheets.
Dimensions: L 585 X W 355 X D 115 mm.	
Brand: LOTO-LOK®	Origin: India
Weight:	Packaging:
	

Model No.:	LSP-02
Description:	SDS STATION - Safety Data Sheets
	includes PVC coated wire rack on panel + two binders to store up to 600 data sheets.
Dimensions: L 555 X W 740 X D 115 mm.	
Brand: LOTO-LOK®	Origin: India
Weight:	Packaging:
	

Model No.:	MSDS-9000-07	
Description:	SDS STATION - Document Storage Box	
	(Empty Box Only). Color: Red.	
Dimensions: 11" x 8.5" x 1.63".		
Brand: Manual-Pak by Custom-Pak	Origin: USA	
Weight:	Packaging:	
		

SCAFFOLDING, LADDER & MICROTAGS

Model No.:	TAG-SCAF-THI
Description:	SCAFFOLDING TAG - HOLDER. Material: ABS/PA6.
Size :	L 305mm x W 92mm.
Brand: LOTO-LOK®	Origin: China
Weight:	Packaging:



Model No.:	TAG-SCAF-THI
Description:	SCAFFOLDING TAG - INSERT. Material: PVC.
Size :	L 210mm x W 85mm.
Brand: LOTO-LOK®	Origin: China
Weight:	Packaging:



Model No.:	TAG-SCAF-BOX
Description:	SCAFFOLDING TAG HOLDER & INSERT Holder Material: ABS/PA6. Insert Material: PVC.
Size :	
Brand: LOTO-LOK®	Origin: China
Weight:	Packaging:

Packaging: 10 Nos. Holders + 20 Nos. Inserts + 02 Nos. Marker Pen per BOX



Model No.:	TAG-LADR-THI
Description:	LADDER INSPECTION - HOLDER.
Size :	L 183mm x W 55.7mm.
Brand:	Origin: China
Weight:	Packaging:



Model No.:	TAG-LADR-THI
Description:	LADDER INSPECTION - INSERT.
Size :	L 183mm x W 52mm.
Brand:	Origin: China
Weight:	Packaging:



Model No.:	TAG-MICR-THI
Description:	Microtag Holder & Insert with Cable Tie.
Size :	L 81mm x W 39mm.
Brand:	Origin: China
Weight:	Packaging:



Model No.:	DH-ACY-YELLOW
Description:	Document Holder - with Clear Door and Group Locking facility. Acrylic construction. Wall mounting. Color: Yellow.
Dimensions:	L410 X W260mm.
Brand: LOTO-LOK®	Origin: China
Weight:	Packaging:



Model No.:	DH-PVC-PTW
Description:	Document Holder - Flexible Sheeting Permit Holder with zip lock & metal eyelet. PTW can be secured with uniquely numbered color coded cable ties.
Dimensions:	L325 mm x W290mm.
Brand: LOTO-LOK®	Origin: China
Weight:	Packaging:



LOTO VINYL STICKERS

Model No.:	RWV-01
Description:	STICKER VINYL - Lockout / Tagout
	Self-Adhesive LOTO Sticker, stick on Equipment & Machines as Visual Aids.
Dimensions: L300 x W150mm. Type: Vertical.	
Brand: LOTO-LOK®	Origin: India
Weight:	Packaging:



Model No.:	RWH-02
Description:	STICKER VINYL - Lockout / Tagout
	Self-Adhesive LOTO Sticker, stick on Equipment & Machines as Visual Aids.
Dimensions: W300 x L150mm. Type: Horizontal.	
Brand: LOTO-LOK®	Origin: India
Weight:	Packaging:



Model No.:	BWH-03
Description:	STICKER VINYL - Lockout / Tagout
	Self-Adhesive LOTO Sticker, stick on Equipment & Machines as Visual Aids.
Dimensions: W300 x L150mm. Type: Horizontal.	
Brand: LOTO-LOK®	Origin: India
Weight:	Packaging:



Model No.:	BWV-04
Description:	STICKER VINYL - Lockout / Tagout
	Self-Adhesive LOTO Sticker, stick on Equipment & Machines as Visual Aids.
Dimensions: L300 x W150mm. Type: Vertical.	
Brand: LOTO-LOK®	Origin: India
Weight:	Packaging:



Model No.:	BWH-05
Description:	STICKER VINYL - Lockout / Tagout
	Self-Adhesive LOTO Sticker, stick on Equipment & Machines as Visual Aids.
Dimensions: W300 x L150mm. Type: Horizontal.	
Brand: LOTO-LOK®	Origin: India
Weight:	Packaging:



Model No.:	RBH-06
Description:	STICKER VINYL - Lockout / Tagout
	Self-Adhesive LOTO Sticker, stick on Equipment & Machines as Visual Aids.
Dimensions: W300 x L150mm. Type: Horizontal.	
Brand: LOTO-LOK®	Origin: India
Weight:	Packaging:



Model No.:	RBV-07
Description:	STICKER VINYL - Lockout / Tagout
	Self-Adhesive LOTO Sticker, stick on Equipment & Machines as Visual Aids.
Dimensions: L300 x W150mm. Type: Vertical.	
Brand: LOTO-LOK®	Origin: India
Weight:	Packaging:



Model No.:	BBH-08
Description:	STICKER VINYL - Lockout / Tagout
	Self-Adhesive LOTO Sticker, stick on Equipment & Machines as Visual Aids.
Dimensions: W300 x L150mm. Type: Horizontal.	
Brand: LOTO-LOK®	Origin: India
Weight:	Packaging:



Model No.:	YRH-09
Description:	STICKER VINYL - Lockout / Tagout
	Self-Adhesive LOTO Sticker, stick on Equipment & Machines as Visual Aids.
Dimensions: W300 x L150mm. Type: Horizontal.	
Brand: LOTO-LOK®	Origin: India
Weight:	Packaging:



LOTO VINYL STICKERS

Model No.:	RBH-10
Description:	STICKER VINYL - Lockout / Tagout
	Self-Adhesive LOTO Sticker, stick on Equipment & Machines as Visual Aids.
Dimensions: W300 x L150mm. Type: Horizontal.	
Brand: LOTO-LOK®	Origin: India
Weight:	Packaging:



Model No.:	RBH-11
Description:	STICKER VINYL - Lockout / Tagout
	Self-Adhesive LOTO Sticker, stick on Equipment & Machines as Visual Aids.
Dimensions: W300 x L150mm. Type: Horizontal.	
Brand: LOTO-LOK®	Origin: India
Weight:	Packaging:



Model No.:	YBH-12
Description:	STICKER VINYL - Lockout / Tagout
	Self-Adhesive LOTO Sticker, stick on Equipment & Machines as Visual Aids.
Dimensions: W300 x L150mm. Type: Horizontal.	
Brand: LOTO-LOK®	Origin: India
Weight:	Packaging:



Model No.:	RBH-13
Description:	STICKER VINYL - Lockout / Tagout
	Self-Adhesive LOTO Sticker, stick on Equipment & Machines as Visual Aids.
Dimensions: W300 x L150mm. Type: Horizontal.	
Brand: LOTO-LOK®	Origin: India
Weight:	Packaging:



LOTO POSTERS

Model No.:	LP-01
Description:	POSTER - Lockout / Tagout. Made from durable Vinyl (Vertical).
Dimensions: L 600 x W 450mm.	
Brand: LOTO-LOK®	Origin: India
Weight:	Packaging:



Model No.:	LP-02
Description:	POSTER - Lockout / Tagout. Made from durable Vinyl (Vertical).
Dimensions: L 600 x W 450mm.	
Brand: LOTO-LOK®	Origin: India
Weight:	Packaging:



Model No.:	LP-03
Description:	POSTER - Lockout / Tagout. Made from durable Vinyl (Vertical).
Dimensions: L 600 x W 450mm.	
Brand: LOTO-LOK®	Origin: India
Weight:	Packaging:



Model No.:	LP-04
Description:	POSTER - Lockout / Tagout. Made from durable Vinyl (Vertical).
Dimensions: L 600 x W 450mm.	
Brand: LOTO-LOK®	Origin: India
Weight:	Packaging:



Model No.:	LP-05
Description:	POSTER - Lockout / Tagout. Made from durable Vinyl (Vertical).
Dimensions: L 600 x W 450mm.	
Brand: LOTO-LOK®	Origin: India
Weight:	Packaging:



Model No.:	LP-06
Description:	POSTER - Lockout / Tagout. Made from durable Vinyl (Vertical).
Dimensions: L 600 x W 450 mm.	
Brand: LOTO-LOK®	Origin: India
Weight:	Packaging:



Model No.:	LP-07
Description:	POSTER - Lockout / Tagout. Made from durable Vinyl (Vertical).
Dimensions: L 600 x W 450mm.	
Brand: LOTO-LOK®	Origin: India
Weight:	Packaging:



ELECTRIC SHOCK & CRANE SAFETY POSTERS

Model No.:	EL-01
Description:	Poster - Electric Shock (Vertical). GB Standard, Manufactured from durable plastic laminate
Dimensions:	750 x 500mm.
Brand:	LOTO-LOK® Origin: India
Weight: Packaging:
	

Model No.:	EL-02
Description:	Tips Poster - Electric Safety (Vertical).
Dimensions:	750 x 500mm.
Brand:	LOTO-LOK® Origin: India
Weight: Packaging:
	

Model No.:	EL-04
Description:	Poster - Electric Shock (Vertical).
Dimensions:	750 x 500mm.
Brand:	LOTO-LOK® Origin: India
Weight: Packaging:
	

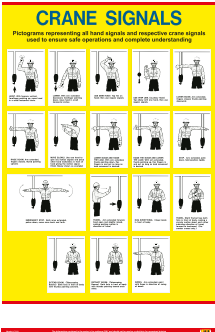
Model No.:	CS-01
Description:	Poster - Crane Signals (Vertical).
Dimensions:	750 x 500mm.
Brand:	LOTO-LOK® Origin: India
Weight: Packaging:
	

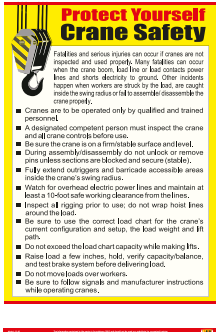
Model No.:	CS-02
Description:	Poster - Crane Safety (Vertical).
Dimensions:	750 x 500mm.
Brand:	LOTO-LOK® Origin: India
Weight: Packaging:
	

FIRST AID POSTERS

Model No.:	FA-01
Description:	Poster - First Aid Eye Injuries (Vertical).
Dimensions:	750 x 500mm.
Brand: LOTO-LOK®	Origin: India
Weight:	Packaging:

Model No.:	FA-02
Description:	Poster - First Aid Chemical and Caustics (Vertical).
Dimensions:	750 x 500mm.
Brand: LOTO-LOK®	Origin: India
Weight:	Packaging:

Model No.:	FA-03
Description:	Poster - First Aid Burns and Scalds (Vertical).
Dimensions:	750 x 500mm.
Brand: LOTO-LOK®	Origin: India
Weight:	Packaging:

Model No.:	FA-04
Description:	Poster - First Aid Chest Injuries (Vertical).
Dimensions:	750 x 500mm.
Brand: LOTO-LOK®	Origin: India
Weight:	Packaging:

Model No.:	FA-05
Description:	Poster - First Aid Artificial Respiration (Vertical).
Dimensions:	750 x 500mm.
Brand: LOTO-LOK®	Origin: India
Weight:	Packaging:

Model No.:	FA-06
Description:	Poster - First Aid Neck and Back Injuries (Vertical).
Dimensions:	750 x 500mm.
Brand: LOTO-LOK®	Origin: India
Weight:	Packaging:

Model No.:	FA-07
Description:	Poster - First Aid Stomach Injuries (Vertical).
Dimensions:	750 x 500mm.
Brand: LOTO-LOK®	Origin: India
Weight:	Packaging:

Model No.:	FA-08
Description:	Poster - First Aid Heart Attacks (Vertical).
Dimensions:	750 x 500mm.
Brand: LOTO-LOK®	Origin: India
Weight:	Packaging:

Model No.:	FA-09
Description:	Poster - First Aid Head Injuries and Nosebleeds (Vertical).
Dimensions:	750 x 500mm.
Brand: LOTO-LOK®	Origin: India
Weight:	Packaging:

FIRST AID POSTERS

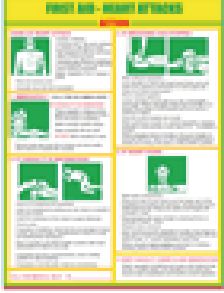
Model No.:	FA-10
Description:	Poster - First Aid Bleeding Cuts and Wounds (Vertical).
Dimensions: 750 x 500mm.	
Brand: LOTO-LOK®	Origin: India
Weight:	Packaging:
	

Model No.:	FA-11
Description:	Poster - First Aid Fits, Convulsions and Choking (Vertical).
Dimensions: 750 x 500mm.	
Brand: LOTO-LOK®	Origin: India
Weight:	Packaging:
	

Model No.:	FA-12
Description:	Poster - First Aid Fractures Dislocations and Sprains (Vertical).
Dimensions: 750 x 500mm.	
Brand: LOTO-LOK®	Origin: India
Weight:	Packaging:
	

Model No.:	FA-13
Description:	Poster - First Aid Transporting the Injured (Vertical).
Dimensions: 750 x 500mm.	
Brand: LOTO-LOK®	Origin: India
Weight:	Packaging:
	

LOCKOUT / TAGOUT & ARC FLASH PPE SAVES LIVES

Is your facility compliant to OSHA 29 CFR 1910.147 standard?

LOCKOUT / TAGOUT

 **Electrical Lockouts**

 **Mechanical Lockouts**

 **Safety Padlocks**

 **Danger Tags**

 **Group Lockout**

 **Identification**

 **Assessment**

 **Demonstration**

 **Supply**

 **Installation Support**

LOTO DEVICES, PADLOCKS AND TAGS FOR ISOLATION OF HAZARDOUS ENERGY



Safety Lockout Padlocks



Lockout Hasps



Circuit Breaker Lockouts



KAB-O-LOK Cable Lockouts



Mechanical Lockouts



Plug Lockouts



Panel Lockouts



Group Lock Box



Key Safe Box



Loto Stations



Key & Padlock Cabinets



Lockout Tags

ELECTRICAL SAFETY SOLUTIONS ARC FLASH PROTECTION PPE



Wall Mounted Rescue Kit



Arc Rated Balaclava



Arc Rated Helmet & Visor



CEI IEC 61243-1 Contact Voltage Detectors



Earthing & Short circuiting kits



Voltage Detectors



LOTO SAFETY REQUISITES TRADING L.L.C.

Belresheed Warehouse No.7, Next To Jacky's Electronics, Nad Al Hamar, P.O Box 114738, Dubai - UAE

Tel: +971-4-4539779 E-mail: info@lotosafetyproducts.com www.lotosafetyproducts.com